

SBX-1202

# **QFX**

WHERE THE PARTY BEGINS™



**INSTRUCTION MANUAL**

**WARNING!**

TO REDUCE THE RISK OF ELECTRIC SHOCK, DO NOT REMOVE THE COVER ON THIS SPEAKER. THERE ARE NO USER-SERVICEABLE PARTS INSIDE. REFER ALL SERVICING TO A QUALIFIED TECHNICIAN

To prevent fire or electric shock, do not expose this equipment to rain or moisture. Do not store or operate this product near any liquids, heat sources such as radiators, heat registers or under extreme weather conditions. Clean only with a dry cloth.

Users should exhibit extra safety when the WARNING or CAUTION symbol appears in this instruction manual and follow all precautions as they are stated.

**¡ADVERTENCIA!**

PARA REDUCIR EL RIESGO DE DESCARGA ELÉCTRICA, NO RETIRE LA CUBIERTA DE ESTE ALTAVOZ. NO HAY PARTES REPARABLES POR EL USUARIO ADENTRO. REFIERA TODAS LAS REPARACIONES A UN TÉCNICO CALIFICADO

Para evitar incendios o descargas eléctricas, no exponga este equipo a la lluvia ni a la humedad. No almacene ni utilice este producto cerca de líquidos, fuentes de calor como radiadores, rejillas de calefacción o bajo condiciones climáticas extremas. Limpie solamente con un paño seco.

Los usuarios deben exhibir una seguridad adicional cuando aparezca el símbolo de ADVERTENCIA o PRECAUCIÓN en este manual de instrucciones y seguir todas las precauciones indicadas.

**WARNING!**

POUR RÉDUIRE LE RISQUE DE CHOC ÉLECTRIQUE, NE RETIREZ PAS LE COUVERCLE DE CET HAUT-PARLEUR. IL N'Y A AUCUNE PIÈCE RÉPARABLE PAR L'UTILISATEUR À L'INTÉRIEUR. RÉFÉREZ TOUTE RÉPARATION À UN TECHNICIEN QUALIFIÉ

Pour éviter tout incendie ou choc électrique, n'exposez pas cet équipement à la pluie ou à l'humidité. Ne stockez pas et n'utilisez pas ce produit à proximité de liquides, de sources de chaleur telles que radiateurs, bouches de chaleur ou dans des conditions météorologiques extrêmes. Nettoyez uniquement avec un chiffon sec.

Les utilisateurs doivent faire preuve d'une sécurité supplémentaire lorsque le symbole AVERTISSEMENT ou ATTENTION apparaît dans ce manuel d'instructions et suivre toutes les précautions telles qu'elles sont énoncées.

## IMPORTANT SAFETY MEASURES

Before using this machine, please read all the safety and operating instructions. These safety and operating instructions should be kept in condition of consultation.



- Electric Power Supply Line:** Keep the power cord safe from being tramped on, pressed on by heavy objects, or pierced. Make sure that the cord has ample space to rest on the ground and is not stressed. **DO NOT** pull or drag the power supply line.
- Ventilation:** This unit must be set in a ventilated space. **DO NOT** cover the vents on the back panel for any reason. If placed alongside a wall, distance the unit a minimum of 10cm to allow air flow.
- Dismantling:** **DO NOT** dismantle or open the unit. This is a high powered unit that can cause serious harm if tampered with. **DO NOT** Open.
- Do not use this Speaker in any wet location, in the rain or any location with high moisture. Do not place any liquids or other objects on the speaker system as this may cause an accidental short.

## MEDIDAS DE SEGURIDAD IMPORTANTES

Antes de utilizar esta máquina, lea todas las instrucciones de seguridad y funcionamiento. Esta seguridad y las instrucciones de funcionamiento deben mantenerse en condiciones de consulta.



- Línea de suministro de energía eléctrica:** Mantenga el cable de alimentación a salvo de ser pisoteado, presionado por objetos pesados o perforado. Asegúrese de que el cable tenga suficiente espacio para descansar en el suelo y no está estresado. **NO** tire ni arrastre de la línea de alimentación.
- Ventilación:** esta unidad debe instalarse en un espacio ventilado. **NO** cubra las rejillas de ventilación del panel posterior por alguna razón. Si se coloca junto a una pared, separe la unidad un mínimo de 10 cm para permitir que el aire fluya. **NO** coloque superficies que puedan restringir el buen flujo de aire.
- Desmontaje:** **NO** desmonte ni abra la unidad. Esta es una unidad de alta potencia que puede causar daño grave si se manipula. **NO** abrir.
- No utilice este altavoz en ningún lugar húmedo, bajo la lluvia o en cualquier lugar con mucha humedad. No haga coloque líquidos u otros objetos sobre el sistema de altavoces, ya que esto puede provocar un cortocircuito accidental.

## MESURES DE SÉCURITÉ IMPORTANTES

Avant d'utiliser cette machine, veuillez lire toutes les instructions de sécurité et d'utilisation. Ces sécurité et les instructions d'utilisation doivent être conservées en état de consultation.



- Ligne d'alimentation électrique:** évitez que le cordon d'alimentation ne soit piétiné, pressé par des objets lourds ou percé. Assurez-vous que le cordon a suffisamment d'espace pour reposer sur le sol et n'est pas stressé. **NE PAS** tirer ni faire glisser ni la ligne d'alimentation.
- Ventilation:** Cet appareil doit être installé dans un espace ventilé. **NE PAS** couvrir les événements du panneau arrière pour quelque raison que ce soit. S'il est placé le long d'un mur, éloignez l'unité d'au moins 10 cm pour permettre la circulation de l'air. **NE PAS** faire de surface qui pourrait restreindre une bonne circulation d'air.
- Démontage:** **NE PAS** démonter ni ouvrir l'unité. Il s'agit d'une unité de haute puissance qui peut causer de graves dommages si elle est altérée. **Ne pas ouvrir.**
- N'utilisez pas ce haut-parleur dans un endroit humide, sous la pluie ou dans un endroit très humide.**  
Ne pas placez des liquides ou d'autres objets sur le système d'enceintes car cela pourrait provoquer un court-circuit accidentel.

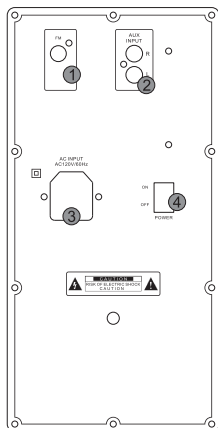
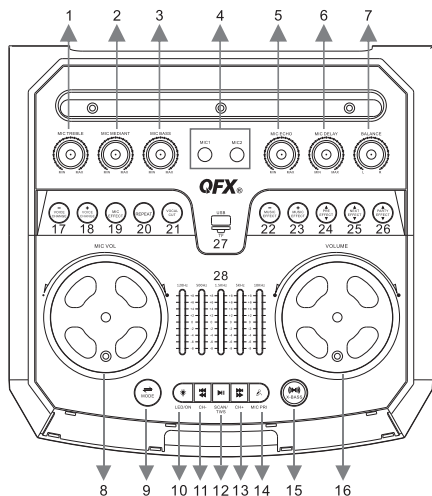

1. FM RADIO
2. AUX INPUT
3. AC POWER
4. POWER SWITCH

1. FM RADIO
2. ENTRADA AUXILIAR
3. ENERGÍA ELÉCTRICA
4. INTERRUPTOR DE ENCENDIDO/APAGADO

1. FM RADIO
2. ENTRÉE AUX
3. ALIMENTATION ÉLECTRIQUE
4. INTERRUPTEUR D'ALIMENTATION

## FUNCTIONS:

1. **MIC TREBLE:** knob to adjust the treble of the microphone;
2. **MIC MIDDIAN:** knob to adjust the midiant of the microphone;
3. **MIC BASS:** knob to adjust the bass of the microphone;
4. **MIC INPUT:** microphone input port;
5. **MIC ECHO:** knob to adjust the echo of the microphone;
6. **MIC DELAY:** knob to adjust the delay of the microphone;
7. **BALANCE:** knob to adjust the balance of microphone & music;
8. **MIC VOL:** knob to adjust the volume of the microphone;
9. **MODE:** press and release to choose Bluetooth , FM , AUX,USB or TF;
10. **LED ON/OFF:** press and release to choose the LED flashing style or close the LED;
11. **PREVIOUS TRACK / FAST BACKWARD/CH-:** press and release to choose previous song, press and hold to fast backward the current song;
12. **PLAY/PAUSE,TWS(FM SCAN):** press and release for pause , press and release again for playing; "TWS function":ensure both two speakers are in Bluetooth mode first, open the Bluetooth on your mobile phone , then connect mobile phone with anyone speaker by BT, press and hold "TWS" button on the speaker which already connected with mobile phone , it will automatically connect with another speaker.
- FM SCAN: when it is on FM mode, press and hold to search the stations;

13. **NEXT TRACK / FAST FORWARD/CH+:** press and release to choose next song, press and hold to fast forward the current song;
14. **MIC PRIORITY:** press and release to open or close MIC PRIORITY function.
15. **EXTRA BASS:** press and release to open or close EXTRA BASS function.
16. **VOLUME:** knob to adjust the volume of the music.
- 17/18. **VOICE CHANGE-/VOICE CHANGE+:** adjust the voice style which input from the microphone.
19. **MIC EFFECT:** press and release to choose different microphone style.
20. **REPEAT:** press and release to repeat current song, press and release again to repeat all songs
21. **VOICE CUT:** Eliminate the human voice from the song.
- 22/23. **MUSIC EFFECT-/ MUSIC DFFECT+:** press and release to choose different music style.
- 24/25/26. **PREVIOUS EFFECT/ NEXT EFFECT/PARTY EFFECT:** choose some party effect,for example:  
Applause, whistles...
27. **USB/TF CARD:** USB/TF CARD input port.
28. **MUSIC EQUALIZER:** Adjust the frequency of the music

## FUNCIONES:

1. **AGUDOS DEL MICRÓFONO:** perilla para ajustar los agudos del micrófono.
2. **MEDIANOS DEL MICRÓFONO:** perilla para ajustar los medios del micrófono.
3. **GRAVES DEL MICRÓFONO:** perilla para ajustar los graves del micrófono.
4. **ENTRADA DE MICRÓFONO:** puerto de entrada del micrófono.
5. **ECHO DEL MICRÓFONO:** perilla para ajustar el eco del micrófono.
6. **RETARDO DEL MICRÓFONO:** perilla para ajustar el retardo del micrófono.
7. **BALANCE:** perilla para ajustar el balance entre el micrófono y la música.
8. **VOLUMEN DEL MICRÓFONO:** perilla para ajustar el volumen del micrófono.
9. **MODO:** presionar y soltar para elegir Bluetooth, FM, AUX, USB o TF.
10. **ENCENDIDO/APAGADO DE LED:** presionar y soltar para elegir el estilo de destello del LED o apagar el LED.
11. **PISTA ANTERIOR / RETROCESO RÁPIDO / CH-:** presionar y soltar para elegir la canción anterior, presionar y mantener presionado para retroceder rápidamente la canción actual.
12. **REPRODUCIR/PAUSAR, TWS (BÚSQUEDA DE FM):** presionar y soltar para pausar, presionar y soltar nuevamente para reproducir; la función "TWS" asegura que ambos altavoces estén en modo Bluetooth primero, abrir el Bluetooth en tu teléfono móvil, luego conectar el teléfono móvil con uno de los altavoces a través de BT, presionar y mantener presionado el botón "TWS" en el altavoz que ya está conectado al teléfono móvil, se conectará automáticamente con el otro altavoz. BÚSQUEDA DE FM: cuando está en modo FM, presionar y mantener presionado para buscar las estaciones.
13. **SIGUIENTE PISTA / AVANCE RÁPIDO / CH+:** presionar y soltar para elegir la siguiente canción, presionar y mantener presionado para avanzar rápidamente la canción actual.
14. **PRIORIDAD DE MICRÓFONO:** presionar y soltar para abrir o cerrar la función de prioridad de micrófono.
15. **EXTRA GRAVES:** presionar y soltar para abrir o cerrar la función de graves adicionales.
16. **VOLUMEN:** perilla para ajustar el volumen de la música.
- 17/18. **CAMBIO DE VOZ- / CAMBIO DE VOZ+:** ajustar el estilo de voz que proviene del micrófono.
19. **CORTE DE VOZ:** eliminar la voz humana de la canción.
20. **USB/TARJETA TF:** puerto de entrada USB/tarjeta TF.
21. **ECUALIZADOR DE MÚSICA:** ajustar la frecuencia de la música.
- 22/23. **EFECTO DE MÚSICA- / EFECTO DE MÚSICA+:** presionar y soltar para elegir diferentes estilos de música.
- 24/25/26. **EFECTO ANTERIOR / EFECTO SIGUIENTE / EFECTO DE FIESTA:** elegir algunos efectos de fiesta, por ejemplo: aplausos, silbidos...
27. **USB/TARJETA TF:** puerto de entrada USB/tarjeta TF.
28. **ECUALIZADOR DE MÚSICA:** ajustar la frecuencia de la música.

## FONCTIONS:

1. **AIGUS DU MICROPHONE:** bouton pour ajuster les aigus du microphone ;
2. **MÉDIANS DU MICROPHONE:** bouton pour ajuster les médians du microphone ;
3. **GRAVES DU MICROPHONE:** bouton pour ajuster les graves du microphone ;
4. **ENTRÉE MICROPHONE:** port d'entrée du microphone ;
5. **ÉCHO DU MICROPHONE:** bouton pour ajuster l'écho du microphone ;
6. **RETARD DU MICROPHONE:** bouton pour ajuster le retard du microphone ;
7. **BALANCE:** bouton pour ajuster la balance entre le microphone et la musique ;
8. **VOLUME DU MICROPHONE:** bouton pour ajuster le volume du microphone ;
9. **MODE:** appuyer et relâcher pour choisir Bluetooth, FM, AUX, USB ou TF ;
10. **LED ON/OFF:** appuyer et relâcher pour choisir le style d'ignotant des LED ou éteindre les LED ;
11. **PISTE PRÉCÉDENTE / RETOUR RAPIDE/CH-:** appuyer et relâcher pour choisir la chanson précédente, appuyer et maintenir enfoncé pour revenir rapidement à la chanson en cours ;
12. **LECTURE/PAUSE, TWS:** appuyer et relâcher pour mettre en pause, appuyer et relâcher à nouveau pour jouer ; la fonction "TWS" assure que les deux haut-parleurs sont en mode Bluetooth d'abord, ouvrir le Bluetooth sur votre téléphone portable, puis connecter le téléphone portable à l'un des haut-parleurs via BT, appuyer et maintenir enfoncé le bouton "TWS" sur le haut-parleur déjà connecté au téléphone portable, il se connectera automatiquement à l'autre haut-parleur. BALAYAGE FM : lorsqu'il est en mode FM, appuyer et maintenir enfoncé pour rechercher les stations ;
13. **PISTE SUIVANTE / AVANCE RAPIDE/CH+:** appuyer et relâcher pour choisir la chanson suivante, appuyer et maintenir enfoncé pour avancer rapidement dans la chanson en cours ;
14. **PRIORITÉ MICROPHONE:** appuyer et relâcher pour ouvrir ou fermer la fonction de priorité du microphone ;
15. **EXTRA GRAVES:** appuyer et relâcher pour ouvrir ou fermer la fonction de graves supplémentaires ;
16. **VOLUME:** bouton pour ajuster le volume de la musique ;
- 17/18. **CHANGEMENT DE VOIX- / CHANGEMENT DE VOIX+:** ajuster le style de voix provenant du microphone ;
17. **EFFET MICROPHONE:** appuyer et relâcher pour choisir un style de microphone différent ;
18. **RÉPÉTITION:** appuyer et relâcher pour répéter la chanson en cours, appuyer et relâcher à nouveau pour répéter toutes les chansons ;
19. **COUPE DE VOIX:** éliminer la voix humaine de la chanson ; 24/25/26. **EFFET PRÉCÉDENT / EFFET SUIVANT / EFFET DE FÊTE:** choisir certains effets de fête, par exemple : applaudissements, sifflements...
20. **USB/CARTE TF:** port d'entrée USB/carte TF ;
21. **ÉGALISEUR DE MUSIQUE:** ajuster la fréquence de la musique.
- 22/23. **EFFET MUSIQUE/EFFET MUSIQUE+:** appuyer et relâcher pour choisir un style de musique différent ;
- 24/25/26. **EFFET PRÉCÉDENT / EFFET SUIVANT / EFFET DE FÊTE:** choisir certains effets de fête, par exemple : applaudissements, sifflements...
27. **USB/CARTE TF:** port d'entrée USB/carte TF.
28. **ÉGALISEUR MUSICAL:** ajuster la fréquence de la musique.

## REMOTE CONTROL CONTROL REMOTO / Télécommandé

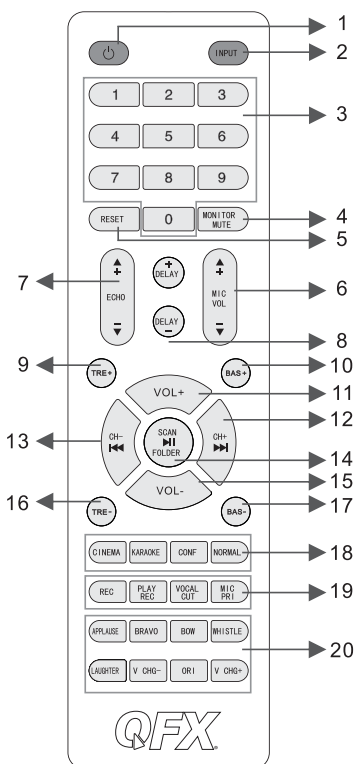

- |                    |                        |
|--------------------|------------------------|
| 1.POWER            | 13.CH -/PREVIOUS TRACK |
| 2.INPUT            | 14.PLAY/PAUSE          |
| 3.NUMERIC KEY      | 15.VOLUME -            |
| 4.MONITOR MUTE     | 16.TREBLE -            |
| 5.RESET            | 17.BASS -              |
| 6.MIC VOL +/-      | 18.SOUND FIELD         |
| 7.ECHO +/-         | 19.RECORDING           |
| 8.DELAY +/-        | PLAY RECORDING         |
| 9.TREBLE +         | VOCAL CUT              |
| 10.BASS +          | MIC PRIORITY           |
| 11.VOLUME +        | 20.SOUND EFFECT        |
| 12.CH +/NEXT TRACK |                        |

- |                         |                        |
|-------------------------|------------------------|
| 1.ENCENDIDO             | 13.CH -/PISTA ANTERIOR |
| 2.ENTRADA               | 14.REPRODUCIR/PAUSAR   |
| 3.TECLA NUMÉRICA        | 15.VOLUMEN -           |
| 4.SILENCIO DE MONITOR   | 16.AGUDOS -            |
| 5.REINICIAR             | 17.GRAVES -            |
| 6.VOL +/- DEL MICRÓFONO | 18.CAMPO DE SONIDO     |
| 7.ECO +/-               | 19.GRABACIÓN           |
| 8.RETARDO +/-           | REPRODUCIR GRABACIÓN   |
| 9.AGUDOS +              | ELIMINAR VOCAL         |
| 10.GRAVES +             | PRIORIDAD DE MICRÓFONO |
| 11.VOLUMEN +            | 20.SOUND EFFECT        |
| 12.CH +/SIGUIENTE PISTA |                        |

- |                            |                              |
|----------------------------|------------------------------|
| 1.ALIMENTATION             | 13.CH +/- / PISTE PRÉCÉDENTE |
| 2.ENTRÉE                   | 14.LECTURE/PAUSE             |
| 3.TOUCHES NUMÉRIQUES       | 15.VOLUME -                  |
| 4.SILENCE MONITEUR         | 16.AIGUS -                   |
| 5.REINITIALISER            | 17.GRAVES -                  |
| 6.VOL +/- MICRO            | 18.CHAMP SONORE              |
| 7.ÉCHO +/-                 | 19.ENREGISTREMENT            |
| 8.DÉCALAGE +/-             | LIRE L'ENREGISTREMENT        |
| 9.AIGUS +                  | SUPPRIMER VOIX               |
| 10.GRAVES +                | PRIORITÉ MICRO               |
| 11.VOLUME +                | 20.EFFET SONORE              |
| 12.CH +/- / PISTE SUIVANTE |                              |



# SBX-1202 OPERATION/OPERACIÓN/OPÉRATION

---

## WIRED MICROPHONE

Insert the microphone plug into the microphone input jack. Adjust the microphone volume knob MIC VOL for proper volume. Adjust the echo depth to the proper position.

Now you can start using your microphone. Please note that both the two microphone and one guitar inputs can't be recorded using the recording function.

## BLUETOOTH

You can connect your Bluetooth-enabled device to listen to your audio tracks from this speaker. Press the MODE button on the speaker, or press the MODE button on the remote control to enter Bluetooth mode, indicated on the LED display. In your Bluetooth device settings, select "QFX SBX-1202" to pair the device to the speaker. Once successful, you will hear a connection sound on the speaker.

## TRUE WIRELESS STEREO (TWS)

1. Turn on both devices of the same model and switch both devices to Bluetooth mode.
2. The distance between the two units should be within 20" (50cm).
3. Press the ►|| TWS button on one speaker only for 3 seconds, and start connecting. Once the connection is successful, the display will show "BLUE" on the other speaker.
4. Turn on your Bluetooth-enabled phone or device and connect to "QFX SBX-1202". The two speakers will automatically connect to each other in True Wireless Stereo (TWS) mode.
5. To disconnect TWS, press and hold the MODE button for 3 seconds.

## USB/TF CARD

Insert the USB or TF card into the USB/TF slot. It will automatically start to play the MP3 music files stored on either the USB drive or TF card. Short-press ►|| to Play/Pause, press ◀◀ and ▶▶ to go to the previous or next track. Press and hold ▶▶ or ◀◀ to turn the speaker volume up or down.

## FM RADIO

Press the M (Mode) button to change to FM radio mode. Then press the ►|| button to search FM channels automatically. This operation will scan all FM stations and save them to memory. The scan procedure will take several minutes to complete and should not be interrupted. Once complete, short-press ◀◀ or ▶▶ to move forward or backward stations. Press and hold ▶▶ or ◀◀ to turn the speaker volume up or down.

---

## MICRÓFONO CON CABLE

Inserte el enchufe del micrófono en el conector de entrada del micrófono. Ajuste la perilla de volumen del micrófono MIC VOL para obtener el volumen adecuado. Ajuste la profundidad del eco en la posición adecuada. Ahora puede comenzar a usar su micrófono. Tenga en cuenta que las dos entradas de micrófono y una de guitarra no se pueden grabar con la función de grabación.

## BLUETOOTH

Puede conectar su dispositivo habilitado para Bluetooth para escuchar sus pistas de audio desde este altavoz. Presione el botón MODE en el altavoz, o presione el botón MODE en el control remoto para ingresar al modo Bluetooth, indicado en la pantalla LED. En la configuración de su dispositivo Bluetooth, seleccione "QFX SBX-1202" para emparejar el dispositivo con el altavoz. Una vez que tenga éxito, escuchará un sonido de conexión en el altavoz.

## Verdadero estéreo inalámbrico (TWS)

1. Encienda ambos dispositivos del mismo modelo y cambie ambos dispositivos al modo Bluetooth.
2. La distancia entre las dos unidades debe ser de 20" (50 cm).
3. Presione el botón ►|| TWS en un altavoz solo durante 3 segundos y comience a conectarse. Una vez que la conexión sea exitosa, la pantalla mostrará "AZUL" en el otro altavoz.
4. Encienda su teléfono o dispositivo con Bluetooth y conéctese a "QFX SBX-1202". Los dos altavoces se conectarán automáticamente entre sí en modo True Wireless Stereo (TWS).
5. Para desconectar TWS, mantenga presionado el botón MODE durante 3 segundos.



# SBX-1202 OPERATION/OPERACIÓN/OPÉRATION

---

## Tarjeta USB/TF

Insere la tarjeta USB o TF en la ranura USB/TF. Comenzará automáticamente a reproducir los archivos de música MP3 almacenados en la unidad USB o en la tarjeta TF. Presione brevemente para Reproducir/Pausar, presione y para ir a la pista anterior o siguiente. Mantenga presionado o para subir o bajar el volumen del altavoz.

## Radio FM

Presione el botón M (Modo) para cambiar al modo de radio FM. Luego presione el botón para buscar canales FM automáticamente. Esta operación escaneará todas las estaciones de FM y las guardará en la memoria. El procedimiento de escaneo tardará varios minutos en completarse y no debe interrumpirse. Una vez completado, presione brevemente o para avanzar o retroceder estaciones. Mantenga presionado o para subir o bajar el volumen del altavoz.

---

## MICRO FILAIRE

Insere el enchufe del micrófono en el conector de entrada del micrófono. Ajuste la perilla de volumen del micrófono MIC VOL para obtener el volumen adecuado. Ajuste la profundidad del eco en la posición adecuada. Ahora puede comenzar a usar su micrófono. Tenga en cuenta que las dos entradas de micrófono y una de guitarra no se pueden grabar con la función de grabación.

## BLUETOOTH

Vous pouvez connecter votre appareil compatible Bluetooth pour écouter vos pistes audio à partir de ce haut-parleur. Appuyez sur le bouton MODE de l'enceinte ou appuyez sur le bouton MODE de la télécommande pour passer en mode Bluetooth, indiqué sur l'écran LED.

Dans les paramètres de votre appareil Bluetooth, sélectionnez "QFX SBX-1202" pour coupler l'appareil au haut-parleur. Une fois réussi, vous entendrez un son de connexion sur le haut-parleur.

## Véritable stéréo sans fil (TWS)

1. Allumez les deux appareils du même modèle et passez les deux appareils en mode Bluetooth.
2. La distance entre les deux unités doit être inférieure à 20" (50 cm).
3. Appuyez sur le bouton ►|| TWS sur un seul haut-parleur pendant 3 secondes et commencez à vous connecter. Une fois la connexion établie, l'écran affichera "BLEU" sur l'autre enceinte.
4. Allumez votre téléphone ou appareil compatible Bluetooth et connectez-vous au « QFX SBX-1202 ». Les deux haut-parleurs se connecteront automatiquement l'un à l'autre en mode True Wireless Stereo (TWS).
5. Pour déconnecter TWS, maintenez enfoncé le bouton MODE pendant 3 secondes.

## Carte USB/TF

Insérez la carte USB ou TF dans la fente USB/TF. Il commencera automatiquement à lire les fichiers musicaux MP3 stockés sur la clé USB ou la carte TF. Appuyez brièvement sur Lecture/Pause, appuyez sur et pour passer à la piste précédente ou suivante. Appuyez longuement sur ou pour augmenter ou diminuer le volume du haut-parleur.

## Radio FM

Appuyez sur le bouton M (Mode) pour passer en mode radio FM. Appuyez ensuite sur le bouton pour rechercher automatiquement les chaînes FM. Cette opération balayera toutes les stations FM et les enregistrera dans la mémoire. La procédure de numérisation prendra plusieurs minutes et ne doit pas être interrompue. Une fois terminé, appuyez brièvement sur ou pour avancer ou reculer les stations. Maintenez enfoncé ou pour augmenter ou diminuer le volume du haut-parleur.





## LIMITED PRODUCT WARRANTY POLICY

Before returning your Product for service under this Warranty, please (i) read the instruction manual carefully and visit our website at [www.qfxusa.com](http://www.qfxusa.com) for Product updates and extended support documentation (e.g., Common Troubleshooting Guides); (ii) if you are still having trouble with your Product, please contact the QFX Customer Support Department.

Subject to the terms and conditions herein, QFX, Inc. (herein after called "QFX") warrants to the original purchaser of the Product ("Customer") that for the applicable Warranty Period listed below, the Product will be free from defects in material or workmanship under normal, non-commercial use ("Defects").

Warranty Period encompasses, as listed below, separate "Coverage Periods" for Parts and Labor, each Coverage Period to begin from the original date of Customer purchase. If Customer returns a defective Product (or any component thereof) during the applicable Warranty Period, QFX will, at its option, during the specified Coverage Periods for Parts and Labor (as applicable either: (i) repair the Product (or, as applicable, any component thereof) or (ii) replace the Product (or, as applicable, any component thereof) with a new or refurbished Product (or, as applicable, any component thereof), in either case free of charge to Customer for Parts and/or Labor (as applicable) during the specified Coverage Period only, and excluding applicable shipping charges (noted below), for which the Customer is responsible. The foregoing states the Customer's exclusive remedy and QFX sole liability for breach of the limited warranty contained herein.

This warranty covers only normal use. This warranty is not transferable. QFX is not responsible for warranty replacement should the QFX label or logo be removed or should the product fail to be properly maintained or fail to function properly as a result of misuse, abuse, immersion in liquids, improper installation, improper shipping, damage caused by disasters such as fire, flood, or service other than by QFX. In addition, this warranty excludes any Product (or, as applicable, any component thereof) that has been subject to or Defects resulting from: (a) any neglect or misuse by a Customer, an accident, improper application, violation of operating instructions for the Product, any other Customer-induced damage, or the alteration or removal of any Product serial number; (b) any modification or repair to Product (or, as applicable, any component thereof) by any party other than QFX or a party authorized in writing by QFX; (c) any damage to Product (or, as applicable, any component thereof) due to power surges, incorrect electrical voltage, misconnection to any device, or malfunction of any device used with the Product (or, as applicable, any component thereof); (d) cosmetic damage to the Product (or, as applicable, any component thereof) caused by normal wear and tear; (e) shipping damage that occurs while the Product is in transit; (f) damage caused by heat sources, sunlight, electromagnetic conditions, or other climatic conditions or (g) any acts of God.





Product is sold to Customer for personal, non-commercial use only. Product is not warranted for Customer's commercial or rental use. In addition, Product is not warranted against failure, and should not be used by Customer for any application where (i) there is a risk that any data stored on Product will be breached or otherwise compromised, or (ii) the data stored on Product is relied upon for medical or lifesaving applications. QFX disclaims any Warranty for any of the foregoing uses to the fullest extent permitted by law. Customer assumes any and all risks associated with such uses of Product, and agrees to indemnify QFX for any damages claimed against QFX for such uses.

EXCEPT FOR EXPRESS WARRANTIES STATED ABOVE AND TO THE MAXIMUM EXTENT PERMITTED BY LAW, THE PRODUCTS ARE PROVIDED "AS IS" AND QFX DISCLAIMS ALL OTHER WARRANTIES, INCLUDING WITHOUT LIMITATION ANY IMPLIED WARRANTY (i) OF MERCHANTABILITY, (ii) OF FITNESS FOR A PARTICULAR PURPOSE, OR (iii) OF NON-INFRINGEMENT OF THIRD PARTY RIGHTS. TO THE MAXIMUM EXTENT PERMITTED BY APPLICABLE LAW, IN NO EVENT WILL QFX BE LIABLE TO CUSTOMER OR ANY THIRD PARTY FOR ANY INDIRECT, SPECIAL, INCIDENTAL, CONSEQUENTIAL, EXEMPLARY OR PUNITIVE DAMAGES, INCLUDING, WITHOUT LIMITATION, ANY LOST PROFITS OR REVENUES, LOSS OR INACCURACY OF ANY DATA OR COST OF SUBSTITUTE GOODS, REGARDLESS OF THE THEORY OF LIABILITY (INCLUDING NEGLIGENCE) AND EVEN IF QFX HAS BEEN ADVISED OF THE POSSIBILITY OF SUCH DAMAGES, QFX AGGREGATE LIABILITY TO CUSTOMER FOR ACTUAL DIRECT DAMAGES FOR ANY CAUSE WHATSOEVER SHALL BE LIMITED TO THE CUMULATIVE PRODUCT FEES PAID BY THAT CUSTOMER FOR THE PRODUCTS CAUSING THE DAMAGES, IF ANY.

This Warranty gives Customer specific rights, and Customer may also have other rights that vary from jurisdiction to jurisdiction. Warning: Some Products may contain components that are small enough to be swallowed. Please keep out of reach of children. In order for the return to be processed, you must send the Product PREPAID to the address below in the original packaging or reasonable substitute to prevent damage and include: (1) a dated sales receipt (which must have a purchase date that falls in the Warranty Period specified in the table below) that indicates the place of purchase, model number of Product, and amount paid, (2) a detailed description of Customer's problem with Product, (3) Customer's full name, phone number, and return address, (3) all of the accessories that came with the Product package must be sent along with the main Product, (4) a cashier's check or money order payable to QFX, Inc., in the amount specified for the item in the product table below for return shipping and handling. If in the case you cannot provide a money order or cashier's check, you can contact The QFX Customer Support Representative to arrange payment via credit card. No returned Product will be shipped back to a PO BOX. If a returned Product is found to have no problem and/or does not include ALL of the requirements indicated above, it may be returned back to the customer and will not be processed.



**QFX USA®, Inc.**  
RMA Processing  
Customer Support Department  
2957 E. 46th Street | Vernon, CA 90058

 **support@qfxusa.com**  
 **(800) 864-CLUB (2582) or (323) 588-6900**  
 **qfxusa.com**  
 **Hours of Operation: Monday – Friday, 9am – 5pm PST**

QFX USA®, Inc.  
RMA Processing  
Customer Support Department  
2957 E. 46th Street | Vernon, CA 90058

support@qfxusa.com  
(800) 864-CLUB (2582) or (323) 588-6900  
qfxusa.com  
Hours of Operation: Monday – Friday, 9am – 5pm PST

All prices and details below are for US Destinations excluding, Hawaii, Alaska and Puerto Rico. For excluded destinations and NON US destinations, please contact The QFX Customer Support Department directly for additional shipping fees and return instructions.

If you do not find your Product below, your Product model conflicts with multiple categories, and/or are unsure of which category the Product you have purchased will fall under, please contact our Customer Support Department for further instruction.

In order to determine the exact shipping cost that must be included with your product or paid for the product being returned, please refer to the table below. Please find the product you wish to return by category or model number prefix. QFX will not provide any return or refund to any customer for merchandise and will only honor the Limited Warranty restrictions mentioned in this document.

Please make sure to follow all directions prior to shipping back your item. If you are not sure what the shipping cost for your item is, or if your item category conflicts in the table below, please feel free to contact the QFX Support Department for further assistance.

PRODUCT CATEGORY	HANDLING	LABOR	PARTS
Earphones, Headphones, Pocket Radios, & Small Bluetooth vSpeakers	\$5.00	1 Year	1 Year
Personal Stereos	\$10.00	1 Year	1 Year
Portable Radio/Cassette	\$15.00	1 Year	1 Year
Large Portable Radio Cassette	\$20.00	1 Year	1 Year
Mobile Audio	\$10.00	1 Year	1 Year
Pro Audio SBX Systems	\$75.00	1 Year	1 Year
Pro Audio PBX Systems	\$75.00	1 Year	1 Year
Televisions	\$25.00	1 Year	1 Year
Telephones	\$10.00	1 Year	1 Year

THE WARRANTY AND REMEDY PROVIDED ABOVE ARE EXCLUSIVE AND IN LIEU OF ALL OTHER EXPRESSED OR IMPLIED WARRANTIES INCLUDING, BUT NOT LIMITED TO, THE IMPLIED WARRANTIES OF MERCHANTABILITY, NON-INFRINGEMENT OR FITNESS FOR A PARTICULAR PURPOSE. SOME LAWS DO NOT ALLOW THE EXCLUSION OF IMPLIED WARRANTIES. IF THESE LAWS APPLY, THEN ALL EXPRESSED OR IMPLIED WARRANTIES ARE LIMITED TO THE WARRANTY PERIOD IDENTIFIED ABOVE. UNLESS STATED HEREIN, ANY STATEMENT OR REPRESENTATIONS MADE BY ANY OTHER PERSONS OR FIRM ARE VOID. EXCEPT AS PROVIDED IN THIS WRITTEN WARRANTY, QFX SHALL NOT BE LIABLE FOR ANY LOSS, INCONVENIENCE, OR DAMAGE, INCLUDING DIRECT, SPECIAL, INCIDENTAL OR CONSEQUENTIAL DAMAGES, RESULTING FROM THE USE OR INABILITY TO USE THE QFX PRODUCT, WHETHER RESULTING FROM BREACH OF WARRANTY OR ANY OTHER LEGAL THEORY.

Some jurisdictions do not allow limitations on how long an implied warranty lasts, and some jurisdictions do not allow the exclusion or limitation of incidental or consequential damages, so the above limitations and exclusions may not apply to you. This warranty gives you special legal rights and you may have other rights which vary from jurisdiction to jurisdiction.

©Copyright Protected 2023



**1-800-864-CLUB (2582)**  
**Mon-Fri 9AM - 5PM (PST)**



**support@qfxusa.com**  
**Mon-Fri 9AM - 5PM (PST)**



[www.qfxusa.com](http://www.qfxusa.com)

1-800-864-CLUB (2582)  
Mon-Fri 9AM – 5PM (PST)

support@qfxusa.com  
Mon-Fri 9AM – 5PM (PST)

# THANK YOU.

**QFX** Where the Party Begins!

We would love to hear about your SBX-1202 journey!  
Tag us **@QFXUSA** to share your stories.

FOLLOW US @QFXUSA

