

PBX-312SM

QFX

WHERE THE PARTY BEGINS



INSTRUCTION MANUAL

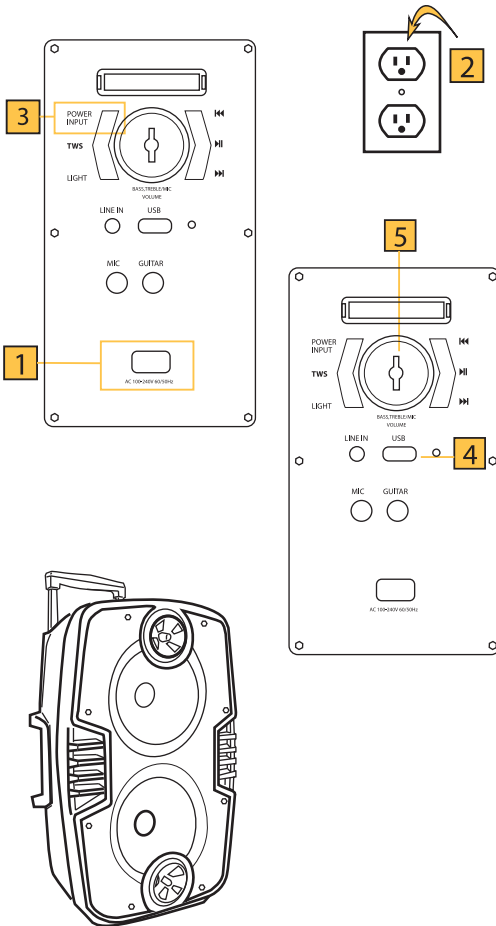

6 - STEP SETUP GUIDE

Step 1 Find the AC power cord to the PBX-312SM located on the back panel of the unit.

Step 2 Find a power outlet (AC 120V/60Hz) and connect the AC cord to the socket to supply the unit with power.

Step 3 Move to the top of part of the panel and press and hold the **POWER INPUT** button. The unit should turn on and begin charging.

Step 4 Insert a USB flash drive in the **USB** port located below the big knob. The PBX-312SM will automatically begin playing the .mp3 content.

Step 5 Use the Big Knob to adjust the **Master Volume** to your taste. Press the Big Knob to enter sub menus such as EQ, Mic Vol, Guitar VOL, Echo, etc.

Step 6 Press the Forward and Rewind keys to move to the next track or previous track. If in FM mode, these keys will change radio station.

BLUETOOTH

Bluetooth Mode: Use the **MODE** button to enable Bluetooth on the PBX-312SM. Open the Bluetooth settings on your mobile device and search for QFX PBX-312SM. Select the option to pair both devices together. You can now sit back and enjoy the music from your favorite app. You won't need reconnect the Bluetooth again when switching through modes.

FM RADIO:

FM Radio: Frequency-Modulated stations operate in a frequency band extending from 87.8 MHz to 108 MHz. Use the **MODE** button to select the FM mode. In FM mode, press the Play/Pause button to scan available frequencies in the area. Extend the telescoping antenna to enhance reception.

TWS CONNECTION:

TWS Wireless Bluetooth Connection: Enable Bluetooth mode on both speakers. Press the **TWS** button for 3 seconds, on one of the speakers, to sync both units (they must be the same make and model to function). On your mobile device under the Bluetooth menu, search for PBX-312SM and connect. Open your favorite music app and enjoy True Wireless Stereo. To Exit TWS press and hold the **TWS** button.

IMPORTANT SAFETY MEASURES

Before using this machine, please read all the safety and operating instructions. These safety and operating instructions should be kept in condition of consultation.



1. **Electric Power Supply Line:** Keep the power cord safe from being trampled on, pressed on by heavy objects, or pierced. Make sure that the cord has ample space to rest on the ground and is not stressed. **DO NOT** pull or drag or the power supply line.
2. **Ventilation:** This unit must be set in a ventilated space. **DO NOT** cover the vents on the back panel for any reason. If placed alongside a wall, distance the unit a minimum of 10cm to allow air flow. **DO NOT** surface that might restricted good air flow.
3. **Dismantling:** **DO NOT** dismantle or open the unit. This is a high-powered unit that can cause serious harm if tampered with. **DO NOT** Open.
4. **Smoke:** Please unplug the power supplies cord from the wall outlet immediately if unusual smoke appears and contact customer support

Questions? Comments? Contact Us Anytime

Preguntas? Comentarios? Contáctenos en cualquier momento
Des questions? Commentaires? Contactez-nous à tout moment



1-800-864-CLUB (2582)
Mon-Fri 9AM - 5PM (PST)



support@qfxusa.com
Mon-Fri 9AM - 5PM (PST)

**WARNING!**

TO REDUCE THE RISK OF ELECTRIC SHOCK, DO NOT REMOVE THE COVER ON THIS SPEAKER. THERE ARE NO USER-SERVICEABLE PARTS INSIDE. REFER ALL SERVICING TO A QUALIFIED TECHNICIAN

To prevent fire or electric shock, do not expose this equipment to rain or moisture. Do not store or operate this product near any liquids, heat sources such as radiators, heat registers or under extreme weather conditions. Clean only with a dry cloth.

Users should exhibit extra safety when the WARNING or CAUTION symbol appears in this instruction manual and follow all precautions as they are stated.

QFX[®]**WHERE THE PARTY BEGINS**

Follow Us



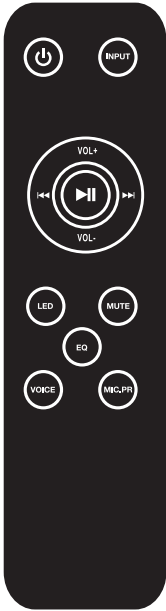



 Stand By: Enable standby mode.

 LED: Select light modes.

 Mute: Mute the Volume

 EQ: Toggle through EQ presets (Pop, Jazz, Rock, Classical).

 Voice: Change Voice quality

 Mic.PR: Microphone Priority over music playback.

 Input: Toggle through input modes, USB/LINE/BT/FM RADIO

 Rewind: Select previous track or FM channel

 Forward: Select next track or FM channel

 Play/Pause: Play or Pause current track

 VOL +: Increase the master volume

 VOL -: Decrease the master volume

4-WAY TWS: BLUETOOTH, USB, AUX, FM RADIO

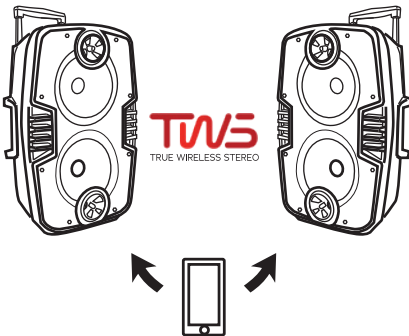

TWS CONNECTION

TWS connection: TWS Connection is only for two speakers of the same make and model.

1. Enable Bluetooth mode on both speakers.
2. Press the **TWS** button on one of the speakers to sync both units together (they must be the same make and model to function).
3. On your mobile device under the Bluetooth menu, search for PBX-312SM and connect.
4. Open your favorite music app and enjoy True Wireless Stereo.
5. To Exit TWS press and hold the **TWS** button.

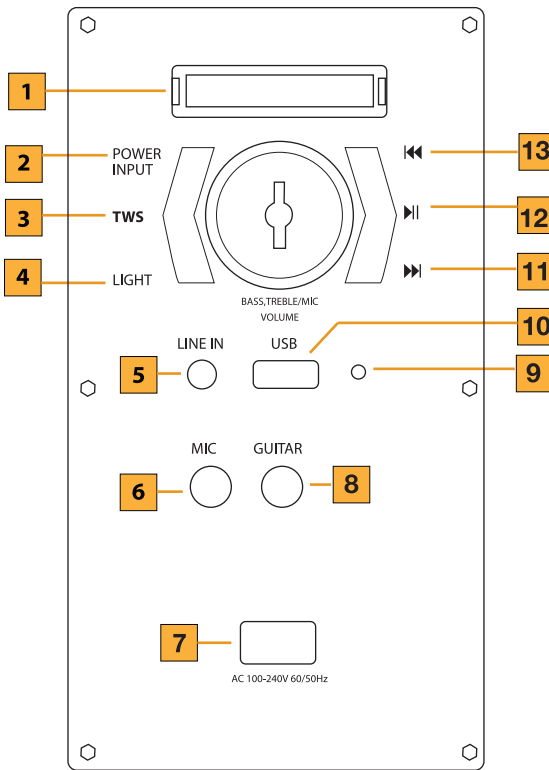

1. Display: Mode Information displayed.
2. POWER INPUT: Turn on the unit. Select the input mode.
3. TWS: Press for TWS sync.
4. Light: Select LED light modes
5. LINE IN: Insert an 3.5mm (TRS) from an external audio device for playback.
6. MIC: Insert a 6.35mm (TS or TRS) microphone cable.
7. AC POWER: 100-240V, 60/50Hz
8. GUITAR: Insert a 6.35 (TS) instrument cable.
9. Charge Status: Battery status.
 - RED = Charging
 - GREEN = Full.
10. USB: Insert an USB to playback .mp3 music.
11. Forward: Next track or FM station.
12. Play/Pause/TWS: Play or Pause current track. Ppress and hold for TWS sync.
13. Rewind: Previous track or FM station.

BASIC OPERATION

1. POWER/INPUT: Press and hold POWER/INPUT button for about 3 seconds to power ON the unit. Press and hold the POWER/INPUT button for about 3 seconds to turn OFF the unit. During working state, press the POWER/INPUT button to select the modes. The sequence is USB (when USB device is connected), LINE, BT, FM.
2. Big Knob: Turn the "Big Knob" to increase and decrease the volume. Press the "Big Knob" to enter the Bass and Treble volume settings.
3. PREVIOUS/NEXT: Press to switch the song and or radio station in FM Mode.
4. PLAY/PAUSE: Play or Pause the current track. During FM state, press PLAY/PAUSE to automatically search radio and save.
5. Light: The unit has LED light brightness adjust function, press LIGHT to choose the effect desired.
6. USB: Playback .mp3 Music for and external USB flash drive.

To control the device via your phone, please download and install the app " Speaker Pro ". Open the App "Speaker Pro" on your phone and choose from the 7 settings page:

1. Bluetooth Music Play: Music app playback
2. USB: USB mp3 Playback
3. Light: Adjust LED light settings
4. FM Radio: Select Stations
5. Bluetooth: Select Bluetooth device
6. Line: mute
7. Sound: Equalize music

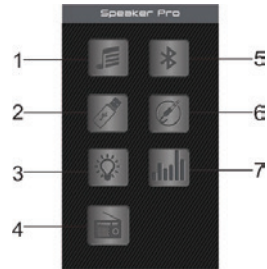

(1) Bluetooth Music play

Press  to enter into the Bluetooth Music play page. Press "Pick songs to play" to choose the song you want to play from your music app. Press "Done" to return to the Bluetooth Music play page. You can use the controllers on the app to navigate.

(2)USB

When inserting a USB into the speaker, press  to enter the USB Card play page. To choose a song and play music on the USB card, press "Play". Use the bottom functions to operate pause, play, backward, forward & volume adjustments. Press "List" to return to the USB list page. Press "Back" to return to the main page.

(3) Light control colours, brightness and colour change mode Press  to enter into Light Control page. You can choose a color from the wheel or a color mode to customize your LED light. To go back to main page, press "<" in the left corner.

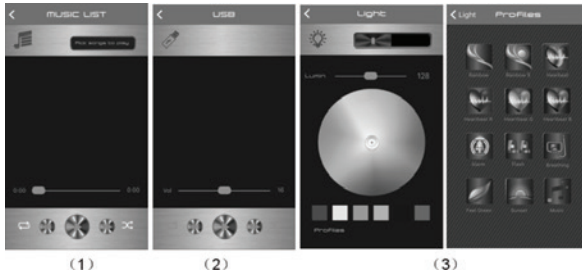

(4) FM Radio:

Press  to enter into FM radio mode. Press SCAN to automatically scan stations.

Press   for radio manual station scan,   Top and bottom for



WHERE THE PARTY BEGINS

Trimming. Turn the TUNER button to sweep through stations. Radio frequency between 87.5MHz~108.0MHz.

(5) Bluetooth connection

Press  to enter into Bluetooth Control connection page, then click PBX-312SM to connect to the speaker.

(6) Line: - mute.

Press  to enter the Line input page. Press  to mute music, press to unmute playback. Press "Back" to main page.

(7) Equalizer regulation

Press  to enter the Sound page. Press MUSIC to adjust the volume, bass and treble on the speaker. There are 4 pre-set EQ modes to choose from: Pop, Classical, Jazz or Rock. You can also press G-EQ to access the graphic equalizer to set up your preferred equalizer specification.

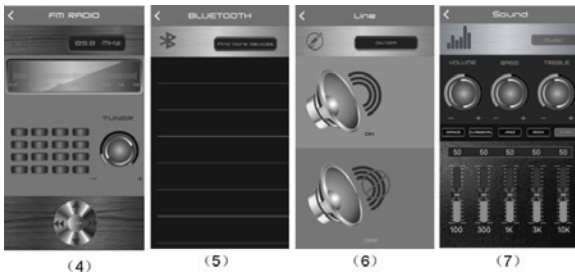

FM OPERATION

Press the Power/Input button to switch to FM mode, Press the PLAY/PAUSE button to automatically scan radio station. By pressing PREVIOUS or NEXT you can select a previous or next station. Press 0~9 from remote to choose the FM stored station.

BLUETOOTH

Press the POWER/INPUT button on the back panel to select Bluetooth mode. Simultaneously open the Bluetooth setting on your phone, tablet, or mobile device and select PBX-312SM. The unit and device will then connect via Bluetooth. To control the device via your phone, tablet etc. please download the App "Speaker Pro". Once the unit and device are connected via Bluetooth, open the "Speaker Pro" App on your mobile device and press the Bluetooth button. This will enable you to control the following five modes: Music, Light, USB Card, Bluetooth and Equalizer. To cancel the app, press the exit button.

SPECIFICATIONS

Power:	40W
Frequency Response:	55Hz-20KHz
Power Supply:	AC 100-240V 60/50Hz

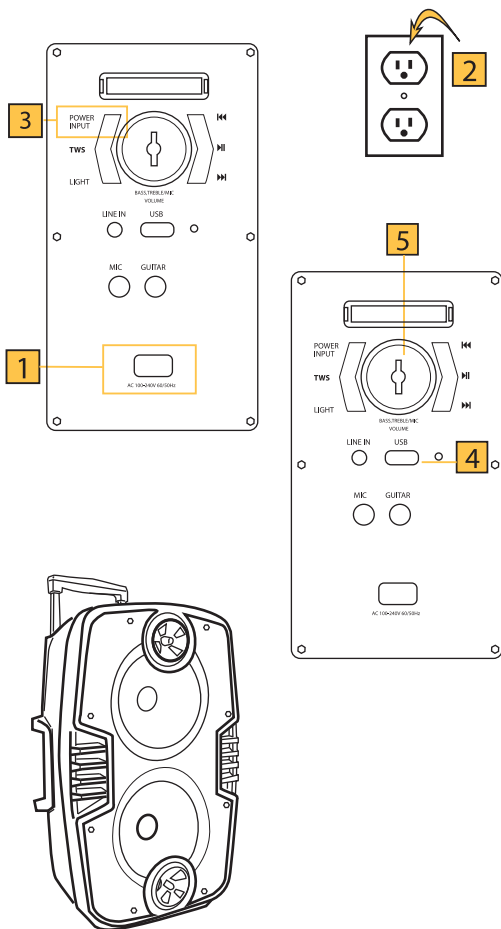

6 - GUÍA DE CONFIGURACIÓN DE PASOS

Paso **1** Busque el cable de alimentación de CA al PBX-312SM ubicado en el panel posterior de la unidad.

Paso **2** Busque una toma de corriente (CA 120V / 60Hz) y conecte el cable de CA al enchufe para suministrar energía a la unidad.

Paso **3** Muévase a la parte superior de la parte del panel y presione y mantenga presionado el botón POWER INPUT. La unidad debe encenderse y comenzar a cargarse.

Paso **4** Inserte una unidad flash USB en el puerto USB ubicado debajo de la perilla grande. El PBX-312SM automáticamente comenzará a reproducir el contenido .mp3.

Paso **5** Utilice el mando grande para ajustar el volumen principal a su gusto. Presione el botón grande para ingresar a los submenús como EQ, Mic Vol, Guitar VOL, Echo, etc.

Paso **6** Pulse las teclas de avance y retroceso para pasar a la siguiente pista o pista anterior. Si está en modo FM, estas teclas cambiarán la estación de radio.

BLUETOOTH

Modo Bluetooth: use el botón MODE para habilitar Bluetooth en el PBX-312SM. Abra la configuración de Bluetooth en su dispositivo móvil y busque QFXPBX-312SM. Seleccione la opción para emparejar ambos dispositivos. Ahora puede sentarse y disfrutar de la música de su aplicación favorita. No necesitará volver a conectar el Bluetooth al cambiar de modo.

FM RADIO:

Radio FM: las estaciones de frecuencia modulada operan en una banda de frecuencia que se extiende desde 87.8 MHz a 108 MHz. Utilice el botón MODE para seleccionar el modo FM. En el modo FM, presione el botón Reproducir / Pausa para buscar las frecuencias disponibles en el área. Extienda la antena telescópica para mejorar la recepción.

CONEXIÓN TWS:

Conexión inalámbrica Bluetooth TWS: habilite el modo Bluetooth en ambos altavoces. Presione el botón TWS en uno de los altavoces para sincronizar ambas unidades (deben ser de la misma marca y modelo para funcionar). En su dispositivo móvil en el menú de Bluetooth, busque PBX-312SM y conéctese. Abra su aplicación de música favorita y disfrute de True Wireless Stereo. Para salir de TWS, mantenga presionado el botón TWS.

MEDIDAS DE SEGURIDAD IMPORTANTES

Antes de utilizar esta máquina, lea todas las instrucciones de seguridad y funcionamiento. Esta seguridad y las instrucciones de funcionamiento deben mantenerse en condiciones de consulta.



1. **Línea de suministro de energía eléctrica:** Mantenga el cable de alimentación a salvo de ser pisoteado, presionado por objetos pesados o perforado. Asegúrese de que el cable tenga suficiente espacio para descansar en el suelo y no está estresado. NO tire ni arrastre de la línea de alimentación.
2. **Ventilación:** esta unidad debe instalarse en un espacio ventilado. NO cubra las rejillas de ventilación del panel posterior por alguna razón. Si se coloca junto a una pared, separe la unidad un mínimo de 10 cm para permitir que el aire fluya. NO coloque superficies que puedan restringir el buen flujo de aire.
3. **Desmontaje:** NO desmonte ni abra la unidad. Esta es una unidad de alta potencia que puede causar daño grave si se manipula. No abra.
4. **Humo:** desenchufe el cable de alimentación del toma de corriente inmediatamente si aparece humo inusual y póngase en contacto con el servicio de atención al cliente.



PARA REDUCIR EL RIESGO DE DESCARGA ELÉCTRICA, NO RETIRE LA CUBIERTA DE ESTE ALTAVOZ. NO HAY PARTES REPARABLES POR EL USUARIO ADENTRO. REFIERA TODAS LAS REPARACIONES A UN TÉCNICO CALIFICADO

Para evitar incendios o descargas eléctricas, no exponga este equipo a la lluvia ni a la humedad. No almacene ni utilice este producto cerca de líquidos, fuentes de calor como radiadores, rejillas de calefacción o bajo condiciones climáticas extremas. Limpie solamente con un paño seco.

Los usuarios deben exhibir una seguridad adicional cuando aparezca el símbolo de ADVERTENCIA o PRECAUCIÓN en este manual de instrucciones y seguir todas las precauciones indicadas.









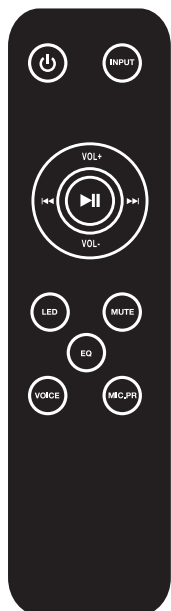





WHERE THE PARTY BEGINS

Follow Us





-  Stand By: habilita el modo de espera.
-  LED: seleccione modos de luz.
-  Silenciar: silenciar el volumen
-  EQ: alterna entre los ajustes preestablecidos de EQ (Pop, Jazz, Rock, Classical).
-  Voz: cambiar la calidad de la VOZ
-  Mic.PR: Prioridad del micrófono sobre la reproducción de música.
-  Entrada: alternar entre los modos de entrada, USB / LINE / BT / FM RADIO
-  Rebobinar: selecciona la pista anterior o el canal FM
-  Adelante: seleccione la siguiente pista o canal FM
-  Reproducir / Pausar: reproducir o pausar la pista actual
-  VOL +: aumenta el volumen principal
-  VOL -: Disminuye el volumen principal

4-MODOS DE TWS: BLUETOOTH, USB, AUX, FM RADIO

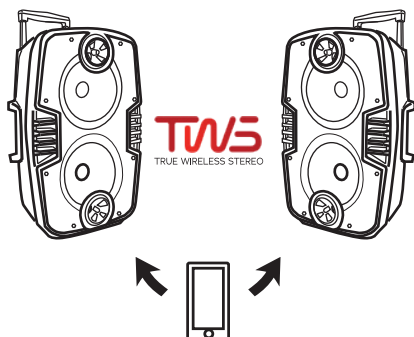

TWS CONNECTION

Conexión TWS: La conexión TWS es solo para dos altavoces de la misma marca y modelo.

1. Habilite el modo Bluetooth en ambos altavoces.
2. Presionado el botón TWS en uno de los altavoces, para sincronizar ambas unidades juntas (deben ser de la misma marca y modelo para funcionar).
3. En su dispositivo móvil en el menú de Bluetooth, busque PBX-312SM y conéctese.
4. Abra su aplicación de música favorita y disfrute de True Wireless Stereo.
5. Para salir de TWS, presione y mantenga presionado el botón TWS.

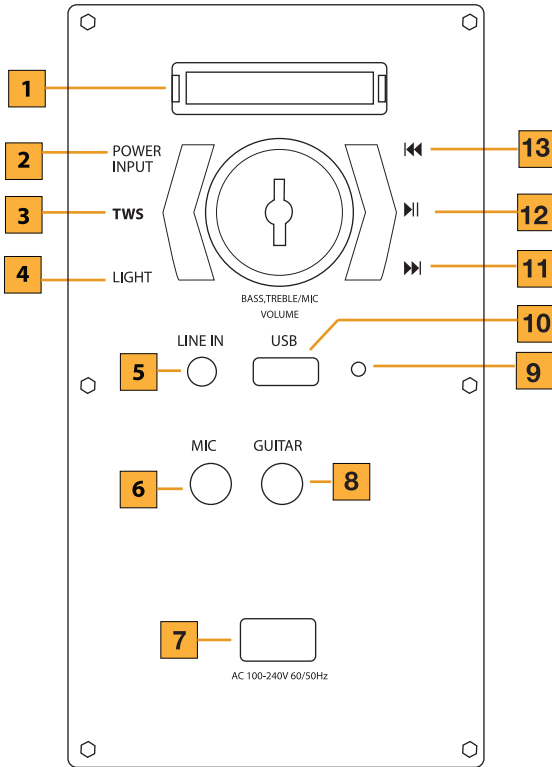

1. Pantalla: se muestra la información del modo.

2. ENTRADA DE ALIMENTACIÓN: Encienda la unidad. Seleccione el modo de entrada.

3. TWS: Presione para sincronizar TWS.

4. Luz: seleccione los modos de luz LED

5. LINE IN: Inserte un 3,5 mm (TRS) de un dispositivo de audio externo para la reproducción.

6. MIC: Inserte un cable de micrófono de 6,35 mm (TS o TRS).

7. ALIMENTACIÓN DE CA: 100-240V, 60/ 50Hz

8. GUITARRA: Inserte un cable de instrumento 6.35 (TS).

9. Estado de carga: estado de la batería.

- ROJO = Cargando
- VERDE = Completo.

10. USB: inserte un USB para reproducir música .mp3.

11. Adelante: siguiente pista o emisora FM.

12. Reproducir / Pausa / TWS: reproduce o pausa la pista actual. Mantenga pulsado para sincronizar TWS.

13. Rebobinar: pista anterior o emisora FM.

OPERACIÓN BÁSICA

1. ENCENDIDO / ENTRADA: Mantenga presionado el botón ENCENDIDO / ENTRADA durante aproximadamente 3 segundos para encender la unidad. Mantenga presionado el botón POWER / INPUT durante aproximadamente 3 segundos para apagar la unidad. Durante el estado de funcionamiento, presione el botón POWER / INPUT para seleccionar los modos. La secuencia es USB (cuando USB dispositivo está conectado), LINE, BT, FM.

2. Perilla grande: Gire la "Perilla grande" para aumentar y bajar el volumen. Presione el "Big Knob" para ingresar a los ajustes de volumen de los Bajos y Agudos.

3. ANTERIOR / SIGUIENTE: presione para cambiar la canción o la estación de radio en el modo FM.

4. PLAY / PAUSE: reproduce o pausa la pista actual. Durante el estado de FM, presione PLAY / PAUSA para buscar radio automáticamente y guardar.

5. Luz: La unidad tiene función de ajuste de brillo de luz LED, presione LIGHT para elegir el efecto deseado.

6. USB: Reproducción de música .mp3 para una unidad flash USB externa.

Para controlar el dispositivo a través de su teléfono, descargue e instale la aplicación "Speaker Pro". Abra la aplicación "Speaker Pro" en su teléfono y elija entre las 7 configuraciones página:

1. Bluetooth Music Play: reproducción de aplicaciones de música
2. USB: Reproducción de mp3 USB
3. Light: ajusta la configuración de la luz LED
4. FM Radio: Seleccionar estaciones
5. Bluetooth: seleccione el dispositivo Bluetooth
6. Línea: mudo
7. sonido: ecualizar música

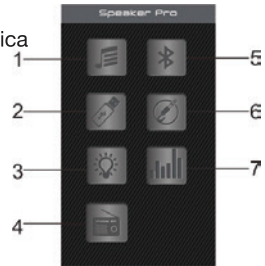

(1) Reproducción de Música Bluetooth

Presione  para ingresar a la página de reproducción de Música Bluetooth. Presiona "Elegir canciones para reproducir" para elegir la canción que desea reproducir desde su aplicación de música. Presione "Listo" para volver a la Página de reproducción de música Bluetooth. Puede utilizar los controladores de la aplicación para navegar.

(2) USB

Al insertar un USB en el altavoz, presione  para ingresar a la reproducción de la tarjeta USB página. Para elegir una canción y reproducir música en la tarjeta USB, presione "Reproducir". Utilizar el funciones inferiores para operar pausa, reproducción, retroceso, avance y ajustes de volumen. Presione "Lista" para volver a la página de la lista USB. Pulsa "Atrás" para Volver a la página principal.

(3) Colores de control de luz, brillo y modo de cambio de color

Presione  para ingresar a la página de Control de luz. Puedes elegir un color de la rueda o un modo de color para personalizar su luz LED. Para volver a la página principal, presione "" en la esquina izquierda.

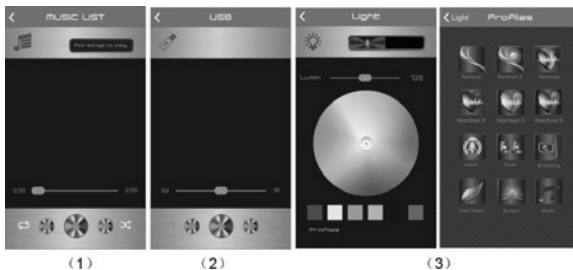

4) Radio FM:

Presione  para ingresar al modo de radio FM. Presione SCAN para buscar estaciones automáticamente.

Presione ◀◀ ▶▶ para escaneo manual de estaciones de radio, ▲ ▼ arriba y abajo para Guarnición. Gire el botón TUNER pour desplazarse por las estaciones. Fréquence radio entre 87,5 MHz ~ 108,0 MHz.

WHERE THE PARTY BEGINS

(5) Conexión Bluetooth

Presione  para ingresar a la page de conexión de Control Bluetooth, luego haga click en PBX-312SM para conectarse al altavoz.

(6) Línea: - mudo.

Presione para ingresar a la página de entrada de línea. Presione  para silenciar la música,

presione  para reactivar la reproducción. Presione "Atrás" a la página principal.

(7) Regulación del ecualizador

Presione  para ingresar a la página de Sonido.

Presione MUSIC para ajustar el volumen, los graves y los agudos en el altavoz. Hay 4 modos de ecualización preestablecidos para elegir: Pop, Clásico, Jazz o Rock. También puede presionar G-EQ para acceder al ecualizador gráfico y configurar su especificación de ecualizador preferida.



Operación FM

Presione el botón de encendido / entrada para cambiar al modo FM, presione el botón PLAY / PAUSE para escanear automáticamente la estación de radio. Pulsando PRÉCÉDENT ou SUIVANT, puede seleccionar una estación anterior o siguiente. Presione 0 ~ 9 desde el control remoto para elegir la estación FM almacenada.

Bluetooth:

Presione el botón POWER / INPUT en el panneau postérieur pour sélectionner el modo Bluetooth. Abra simultáneamente la configuración de Bluetooth en su teléfono, tableta o dispositivo móvil y selección PBX-312SM. La unidad y el dispositivo se conectarán a través de Bluetooth. Para controlar el dispositivo a través de su teléfono, tableta, etc., descargue the aplicación "Speaker Pro". Una vez que la unidad y el dispositivo estén conectados a través de Bluetooth, abra la aplicación "Speaker Pro" en su dispositivo móvil y presione el botón Bluetooth. Esto le permitirá controle los siguientes modos cinco: Música, Luz, Tarjeta USB, Bluetooth et Ecualizador. Para cancelar la aplicación, presione el botón Salir.

Spécificaciones:

Poder: 40 W
Respuesta frecuente
pour altavoz principal: 55Hz-20KHz
Fonction d'alimentation: AC 100-240V 60/50Hz

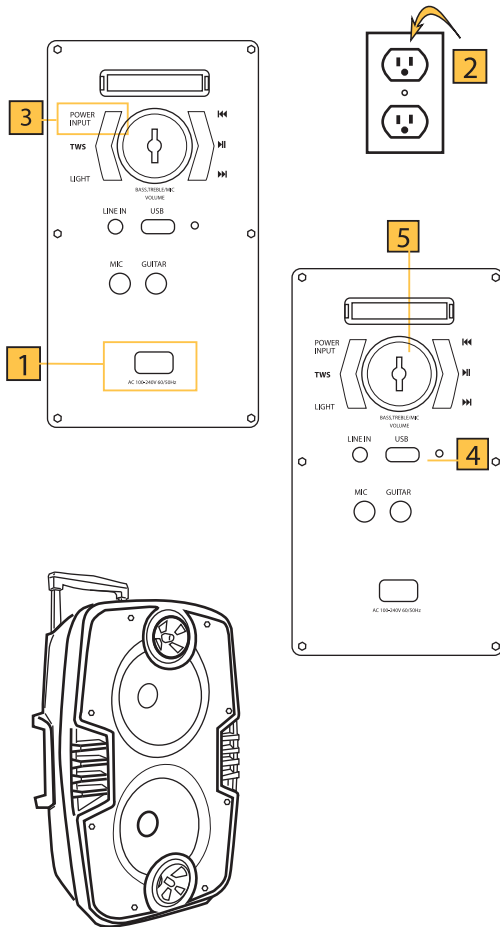

6 - GUIDE DE CONFIGURATION DES ÉTAPES

Étape **1** Trouvez le cordon d'alimentation secteur du PBX-312SM situé sur le panneau arrière de l'unité.

Étape **2** Trouvez une prise de courant (120 V CA / 60 Hz) et branchez le cordon d'alimentation CA à la prise pour alimenter l'unité.

Étape **3** Déplacez-vous vers le haut d'une partie du panneau et maintenez le bouton POWER INPUT enfoncé. L'appareil doit s'allumer et commencer à se charger.

Étape **4** Insérez une clé USB dans le port USB situé sous le gros bouton. Le PBX-312SM commencera automatiquement la lecture du contenu .mp3.

Étape **5** Utilisez le gros bouton pour régler le volume principal à votre goût. Appuyez sur le gros bouton pour accéder aux sous-menus tels que EQ, Mic Vol, Guitar VOL, Echo, etc.

Étape **6** Appuyez sur les touches Avance et Retour pour passer à la piste suivante ou à la piste précédente. En mode FM, ces touches changeront la fonction radio.

BLUETOOTH:

Mode Bluetooth: utilisez le bouton MODE pour activer Bluetooth sur l' PBX-312SM. Ouvrez les paramètres Bluetooth sur votre appareil mobile et recherchez QFX PBX-312SM. Sélectionnez l'option pour coupler les deux appareils ensemble. Vous pouvez maintenant vous asseoir et profiter de la musique de votre application préférée. Vous n'aurez pas besoin de reconnecter le Bluetooth lors du passage d'un mode à l'autre.

FM RADIO:

Radio FM: Les stations à modulation de fréquence fonctionnent dans une bande de fréquences allant de 87,8 MHz à 108 MHz. Utilisez le bouton MODE pour sélectionner le mode FM. En mode FM, maintenez le bouton Lecture / Pause enfoncé pour balayer les fréquences disponibles dans la zone. Déployez l'antenne télescopique pour améliorer la réception.

CONNEXION TWS:

Connexion sans fil Bluetooth TWS: activez le mode Bluetooth sur les deux enceintes. Appuyez sur le bouton TWS de l'une des enceintes pour synchroniser les deux unités (elles doivent être de la même marque et du même modèle pour fonctionner). Sur votre appareil mobile, dans le menu Bluetooth, recherchez PBX-312SM et connectez-vous. Ouvrez votre application musicale préférée et profitez de True Wireless Stereo. Pour quitter TWS, maintenez le bouton TWS enfoncé.

MESURES DE SÉCURITÉ IMPORTANTES

Avant d'utiliser cette machine, veuillez lire toutes les instructions de sécurité et d'utilisation. Ces sécurité et les instructions d'utilisation doivent être conservées en état de consultation.



1. **Ligne d'alimentation électrique:** évitez que le cordon d'alimentation ne soit piétiné, pressé par des objets lourds ou percé. Assurez-vous que le cordon a suffisamment d'espace pour reposer sur le sol et n'est pas stressé. NE PAS tirer ni faire glisser ni la ligne d'alimentation.
2. **Ventilation:** Cet appareil doit être installé dans un espace ventilé. NE PAS couvrir les événements du panneau arrière pour quelque raison que ce soit. S'il est placé le long d'un mur, éloignez l'unité d'au moins 10 cm pour permettre la circulation de l'air. NE PAS faire de surface qui pourrait restreindre une bonne circulation d'air.
3. **Démontage:** NE PAS démonter ni ouvrir l'unité. Il s'agit d'une unité de haute puissance qui peut causer de graves dommages si elle est altérée. Ne pas ouvrir.
4. **Fumée:** débranchez immédiatement le cordon d'alimentation de la prise murale si de la fumée inhabituelle apparaît et contactez le service client.

**ATTENTION**

POUR RÉDUIRE LE RISQUE DE CHOC ÉLECTRIQUE, NE RETIREZ PAS LE COUVERCLE DE CET HAUT-PARLEUR. IL N'Y A AUCUNE PIÈCE RÉPARABLE PAR L'UTILISATEUR À L'INTÉRIEUR. RÉFÉREZ TOUT RÉPARATION À UN TECHNICIEN QUALIFIÉ

Pour éviter tout incendie ou choc électrique, n'exposez pas cet équipement à la pluie ou à l'humidité. Ne stockez pas et n'utilisez pas ce produit à proximité de liquides, de sources de chaleur telles que radiateurs, bouches de chaleur ou dans des conditions météorologiques extrêmes. Nettoyez uniquement avec un chiffon sec.









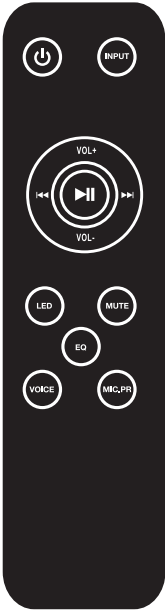



Les utilisateurs doivent faire preuve d'une sécurité supplémentaire lorsque le symbole AVERTISSEMENT ou ATTENTION apparaît dans ce manuel d'instructions et suivre toutes les précautions telles qu'elles sont énoncées.

QFX[®]**WHERE THE PARTY BEGINS**

Follow Us





-  Veille: active le mode veille.
-  LED: Sélectionnez les modes d'éclairage.
-  Muet: couper le volume
-  EQ: permet de basculer entre les préréglages d'égalisation (Pop, Jazz, Rock, Classique).
-  Voix: changer la qualité de la voix
-  Mic.PR: priorité du microphone sur la lecture de musique.
-  Entrée: basculer entre les modes d'entrée, USB / LINE / BT / FM RADIO
-  Rembobiner: sélectionnez la piste ou la chaîne FM précédente
-  Avant: sélectionnez la piste ou la chaîne FM suivante
-  Lecture / Pause: lecture ou pause de la piste actuelle
-  VOL +: augmente le volume principal
-  VOL -: Diminue le volume principal

4-MODOS DE TWS: BLUETOOTH, USB, AUX, FM RADIO

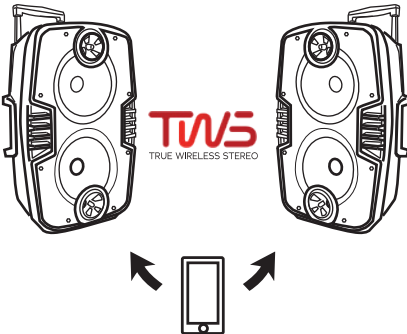

CONNEXION TWS

Connexion TWS: la connexion TWS ne concerne que deux enceintes de la même marque et du même modèle.

1. Activez le mode Bluetooth sur les deux enceintes.
2. En appuyant sur le bouton TWS de l'une des enceintes, pour synchroniser les deux unités ensemble (elles doivent être de la même marque et du même modèle pour fonctionner).
3. Sur votre appareil mobile dans le menu Bluetooth, recherchez PBX-312SM et connectez-vous.
4. Ouvrez votre application musicale préférée et profitez de True Wireless Stereo.
5. Pour quitter TWS, maintenez le bouton TWS enfoncé.

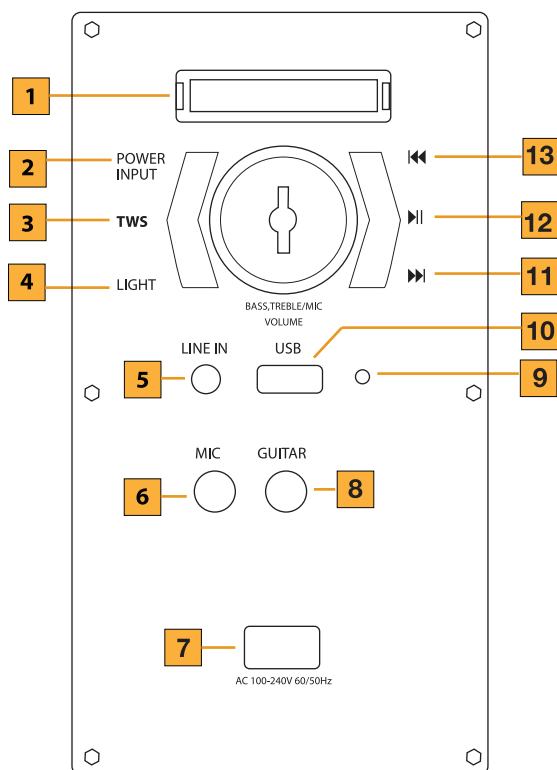

1. Affichage: informations de mode affichées.
2. ENTRÉE D'ALIMENTATION: Allumez l'appareil. Sélectionnez le mode d'entrée.
3. TWS: Appuyez sur pour la synchronisation TWS.
4. Lumière: Sélectionnez les modes d'éclairage LED
5. LINE IN: Insérez un jack 3.5 mm (TRS) d'un périphérique audio externe pour la lecture.
6. MIC: Insérez un câble de microphone 6,35 mm (TS ou TRS).
7. ALIMENTATION AC: 100-240V, 60/50Hz
8. GUITARE: Insérez un câble d'instrument 6,35 (TS).
9. État de charge: état de la batterie.
 - ROUGE = Chargement
 - VERT = Plein.
10. USB: insérez une clé USB pour lire de la musique .mp3.
11. Avancer: piste ou station FM suivante.
12. Lecture / Pause / TWS: lecture ou pause de la piste actuelle. Ppress et maintenez pour la synchronisation TWS.
13. Rewind: piste précédente ou station FM.

OPÉRATION DE BASE

1. POWER / INPUT: Appuyez sur le bouton POWER / INPUT et maintenez-le enfoncé pendant environ 3 secondes pour allumer l'appareil. Appuyez sur le bouton POWER / INPUT et maintenez-le enfoncé pendant environ 3 secondes pour éteindre l'appareil. Pendant l'état de fonctionnement, appuyez sur le bouton POWER / INPUT pour sélectionner les modes. La séquence est USB (lorsque USB appareil connecté), LINE, BT, FM.
2. Big Knob: Tournez le "Big Knob" pour augmenter et diminuer le volume. Appuyez sur le "Big Knob" pour entrer les paramètres de volume des graves et des aigus.
3. PREVIOUS / NEXT: Appuyez pour basculer la chanson et / ou la station de radio en mode FM.
4. PLAY / PAUSE: lecture ou pause de la piste actuelle. Pendant l'état FM, appuyez sur PLAY/PAUSE pour rechercher automatiquement la radio et enregistrer.
5. Light: L'unité dispose d'une fonction de réglage de la luminosité de la lumière LED, appuyez sur LIGHT pour choisir l'effet souhaité.
6. USB: lecture de musique .mp3 pour et clé USB externe.

Pour contrôler l'appareil via votre téléphone, téléchargez et installez l'application «Speaker Pro». Ouvrez l'application «Speaker Pro» sur votre téléphone et choisissez parmi les 7 paramètres page:

1. Bluetooth Music Play: lecture de l'application musicale
2. USB: lecture mp3 USB
3. lumière: ajustez les paramètres d'éclairage LED
4. FM Radio: Sélectionnez les stations
5. Bluetooth: sélectionnez le périphérique Bluetooth
6. ligne: muet
7. son: égaliser la musique

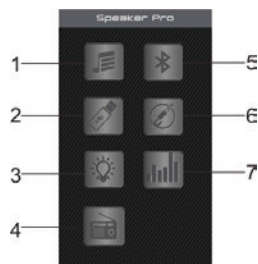

(1) Lecture de musique Bluetooth

Appuyez  pour accéder à la page de lecture de musique Bluetooth. Appuyez sur "Choisir les chansons à lire" pour choisir la chanson que vous souhaitez lire à partir de votre application musicale. Appuyez sur "Terminé" pour revenir à la page de lecture de musique Bluetooth. Vous pouvez utiliser les contrôleurs d'application pour naviguer.

(2) USB

Lors de l'insertion d'une clé USB dans l'enceinte, appuyez  pour accéder à la lecture de la carte USB page. Pour choisir une chanson et lire de la musique sur la carte USB, appuyez sur "Play". Utilisez les fonctions inférieures pour activer la pause, la lecture, le rebobinage, l'avance et paramètres de volume. Appuyez sur "Liste" pour revenir à la page de liste USB. Appuyez sur "Retour" pour revenir à la page principale.

(3) Couleurs de contrôle de la lumière, luminosité et mode de changement de couleur

Appuyez  sur pour accéder à la page Light Control. Vous pouvez choisir une couleur de roue ou un mode couleur pour personnaliser votre éclairage LED. Pour revenir à la page principale, appuyez sur "" dans le coin gauche.

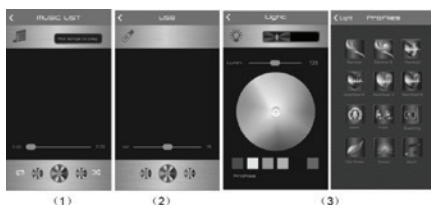

(4) Radio FM:



Appuyez  pour entrer en mode radio FM. Appuyez sur SCAN pour rechercher automatiquement les stations.

Appuyez  sur pour le balayage manuel des stations radio ▲ ▼
Garniture. Tournez le bouton TUNER pour parcourir les stations. Fréquence radio entre 87,5 MHz ~ 108,0 MHz.

(5) Connexion Bluetooth

Appuyez  sur pour accéder à la page de connexion de contrôle Bluetooth, puis cliquez sur **PBX-312SM** pour vous connecter à l'enceinte.

(6) Ligne: - muet.

Appuyez  sur pour accéder à la page d'entrée de ligne. Appuyez  pour couper la musique, appuyez sur pour réactiver la lecture. Appuyez sur "Retour" à la page principale.

(7) Régulation de l'égaliseur

Appuyez  sur pour accéder à la page Son. Appuyez sur **MUSIC** pour régler le volume, les graves et les aigus du haut-parleur. Vous avez le choix entre 4 modes d'égalisation prédéfinis: Pop, Classique, Jazz ou Rock. Vous pouvez également appuyer sur **G-EQ** pour accéder à l'égaliseur graphique afin de configurer votre spécification d'égaliseur préférée.



FONCTIONNEMENT FM

Appuyez sur le bouton Alimentation / Entrée pour passer en mode FM, appuyez et bouton **PLAY / PAUSE** pour balayer automatiquement la station de radio. En appuyant sur **PREVIOUS** ou **NEXT**, vous pouvez sélectionner une station précédente ou suivante. Appuyez sur 0 ~ 9 depuis la télécommande pour choisir la station FM mémorisée.

BLUETOOTH

Appuyez sur le bouton **POWER / INPUT** du panneau arrière pour sélectionner le mode Bluetooth. Ouvrez simultanément le paramètre Bluetooth sur votre téléphone, tablette ou appareil mobile et sélectionnez **PBX-312SM**. L'unité et l'appareil se connecteront ensuite via Bluetooth. Pour contrôler l'appareil via votre téléphone, tablette, etc., veuillez télécharger l'application «Speaker Pro». Une fois que l'appareil et l'appareil sont connectés via Bluetooth, ouvrez l'application «Speaker Pro» sur votre appareil mobile et appuyez sur le bouton Bluetooth. Cela vous permettra de contrôler les cinq modes suivants: Musique, Lumière, Carte USB, Bluetooth et Égaliseur. Pour annuler l'application, appuyez sur le bouton de sortie.

CARACTÉRISTIQUES

Puissance: 40 W

Réponse en fréquence: 55Hz-20KHz

Alimentation: AC 100-240V 60/50Hz

WHERE THE PARTY BEGINS



LIMITED PRODUCT WARRANTY POLICY

Before returning your Product for service under this Warranty, please (i) read the instruction manual carefully and visit our website at www.qfxusa.com for Product updates and extended support documentation (e.g., Common Troubleshooting Guides); (ii) if you are still having trouble with your Product, please contact the QFX Customer Support Department.

Subject to the terms and conditions herein, QFX, Inc. (herein after called "QFX") warrants to the original purchaser of the Product ("Customer") that for the applicable Warranty Period listed below, the Product will be free from defects in material or workmanship under normal, non-commercial use ("Defects").

Warranty Period encompasses, as listed below, separate "Coverage Periods" for Parts and Labor, each Coverage Period to begin from the original date of Customer purchase. If Customer returns a defective Product (or any component thereof) during the applicable Warranty Period, QFX will, at its option, during the specified Coverage Periods for Parts and Labor (as applicable either: (i) repair the Product (or, as applicable, any component thereof) or (ii) replace the Product (or, as applicable, any component thereof) with a new or refurbished Product (or, as applicable, any component thereof), in either case free of charge to Customer for Parts and/or Labor (as applicable) during the specified Coverage Period only, and excluding applicable shipping charges (noted below), for which the Customer is responsible. The foregoing states the Customer's exclusive remedy and QFX sole liability for breach of the limited warranty contained herein.

This warranty covers only normal use. This warranty is not transferable. QFX is not responsible for warranty replacement should the QFX label or logo be removed or should the product fail to be properly maintained or fail to function properly as a result of **misuse, abuse, immersion in liquids, improper installation, improper shipping, damage caused by disasters such as fire, flood, or service other than by QFX.** In addition, this warranty excludes any Product (or, as applicable, any component thereof) that has been subject to or Defects resulting from: (a) any neglect or misuse by a Customer, an accident, improper application, violation of operating instructions for the Product, any other Customer-induced damage, or the alteration or removal of any Product serial number; (b) any modification or repair to Product (or, as applicable, any component thereof) by any party other than QFX or a party authorized in writing by QFX; (c) any damage to Product (or, as applicable, any component thereof) due to power surges, incorrect electrical voltage, misconnection to any device, or malfunction of any device used with the Product (or, as applicable, any component thereof); (d) cosmetic damage to the Product (or, as applicable, any component thereof) caused by normal wear and tear; (e) shipping damage that occurs while the Product is in transit; (f) damage caused by heat sources, sunlight, electromagnetic conditions, or other climatic conditions or (g) any acts of God.

Product is sold to Customer for personal, non-commercial use only. Product is not warranted for Customer's commercial or rental use. In addition, Product is not warranted against failure, and should not be used by Customer for any application where (i) there is a risk that any data stored on Product will be breached or otherwise compromised, or (ii) the data stored on Product is relied upon for medical or lifesaving applications. QFX disclaims any Warranty for any of the foregoing uses to the fullest extent permitted by law. Customer assumes any and all risks associated with such uses of Product, and agrees to indemnify QFX for any damages claimed against QFX for such uses.

EXCEPT FOR EXPRESS WARRANTIES STATED ABOVE AND TO THE MAXIMUM EXTENT PERMITTED BY LAW, THE PRODUCTS ARE PROVIDED "AS IS" AND QFX DISCLAIMS ALL OTHER WARRANTIES, INCLUDING WITHOUT LIMITATION ANY IMPLIED WARRANTY (i) OF MERCHANTABILITY, (ii) OF FITNESS FOR A PARTICULAR PURPOSE, OR (iii) OF NON-INFRINGEMENT OF THIRD PARTY RIGHTS. TO THE MAXIMUM EXTENT PERMITTED BY APPLICABLE LAW, IN NO EVENT WILL QFX BE LIABLE TO CUSTOMER OR ANY THIRD PARTY FOR ANY INDIRECT, SPECIAL, INCIDENTAL, CONSEQUENTIAL, EXEMPLARY OR PUNITIVE DAMAGES, INCLUDING, WITHOUT LIMITATION, ANY LOST PROFITS OR REVENUES, LOSS OR INACCURACY OF ANY DATA OR COST OF SUBSTITUTE GOODS, REGARDLESS OF THE THEORY OF LIABILITY (INCLUDING NEGLIGENCE) AND EVEN IF QFX HAS BEEN ADVISED OF THE POSSIBILITY OF SUCH DAMAGES, QFX AGGREGATE LIABILITY TO CUSTOMER FOR ACTUAL DIRECT DAMAGES FOR ANY CAUSE WHATSOEVER SHALL BE LIMITED TO THE CUMULATIVE PRODUCT FEES PAID BY THAT CUSTOMER FOR THE PRODUCTS CAUSING THE DAMAGES, IF ANY.

This Warranty gives Customer specific rights, and Customer may also have other rights that vary from jurisdiction to jurisdiction. Warning: Some Products may contain components that are small enough to be swallowed. Please keep out of reach of children. In order for the return to be processed, you must send the Product PREPAID to the address below in the original packaging or reasonable substitute to prevent damage and include: (1) a dated sales receipt (which must have a purchase date that falls in the Warranty Period specified in the table below) that indicates the place of purchase, model number of Product, and amount paid, (2) a detailed description of Customer's problem with Product, (3) Customer's full name, phone number, and return address, (3) all of the accessories that came with the Product package must be sent along with the main Product, (4) a cashier's check or money order payable to QFX, Inc., in the amount specified for the item in the product table below for return shipping and handling. If in the case you cannot provide a money order or cashier's check, you can contact The QFX Customer Support Representative to arrange payment via credit card. No returned Product will be shipped back to a PO BOX. If a returned Product is found to have no problem and/or does not include ALL of the requirements indicated above, it may be returned back to the customer and will not be processed.

QFX USA, Inc.
RMA Processing
Customer Support Department
2957 E. 46th Street | Vernon, CA 90058

support@qfxusa.com
(800) 864-CLUB (2582) or (323) 864-6900
qfxusa.com
Hours of Operation: Monday - Friday, 9am - 5pm PST

All prices and details below are for US Destinations excluding, Hawaii, Alaska and Puerto Rico. For excluded destinations and NON US destinations, please contact The QFX Customer Support Department directly for additional shipping fees and return instructions.

If you do not find your Product below, your Product model conflicts with multiple categories, and/or are unsure of which category the Product you have purchased will fall under, please contact our Customer Support Department for further instruction.

In order to determine the exact shipping cost that must be included with your product or paid for the product being returned, please refer to the table below. Please find the product you wish to return by category or model number prefix. QFX will not provide any return or refund to any customer for merchandise and will only honor the Limited Warranty restrictions mentioned in this document.

Please make sure to follow all directions prior to shipping back your item. If you are not sure what the shipping cost for your item is, or if your item category conflicts in the table below, please feel free to contact the QFX Support Department for further assistance.

PRODUCT CATEGORY	HANDLING	LABOR	PARTS
Earphones, Headphones, Pocket Radios, & Small Bluetooth vSpeakers	\$5.00	1 Year	1 Year
Personal Stereos	\$10.00	1 Year	1 Year
Portable Radio/Cassette	\$15.00	1 Year	1 Year
Large Portable Radio Cassette	\$20.00	1 Year	1 Year
Mobile Audio	\$10.00	1 Year	1 Year
Pro Audio SBX Systems	\$75.00	1 Year	1 Year
Pro Audio PBX Systems	\$75.00	1 Year	1 Year
Televisions	\$25.00	1 Year	1 Year
Telephones	\$10.00	1 Year	1 Year

THE WARRANTY AND REMEDY PROVIDED ABOVE ARE EXCLUSIVE AND IN LIEU OF ALL OTHER EXPRESSED OR IMPLIED WARRANTIES INCLUDING, BUT NOT LIMITED TO, THE IMPLIED WARRANTIES OF MERCHANTABILITY, NON-INFRINGEMENT OR FITNESS FOR A PARTICULAR PURPOSE. SOME LAWS DO NOT ALLOW THE EXCLUSION OF IMPLIED WARRANTIES. IF THESE LAWS APPLY, THEN ALL EXPRESSED OR IMPLIED WARRANTIES ARE LIMITED TO THE WARRANTY PERIOD IDENTIFIED ABOVE. UNLESS STATED HEREIN, ANY STATEMENT OR REPRESENTATIONS MADE BY ANY OTHER PERSONS OR FIRM ARE VOID. EXCEPT AS PROVIDED IN THIS WRITTEN WARRANTY, QFX SHALL NOT BE LIABLE FOR ANY LOSS, INCONVENIENCE, OR DAMAGE, INCLUDING DIRECT, SPECIAL, INCIDENTAL OR CONSEQUENTIAL DAMAGES, RESULTING FROM THE USE OR INABILITY TO USE THE QFX PRODUCT, WHETHER RESULTING FROM BREACH OF WARRANTY OR ANY OTHER LEGAL THEORY.

Some jurisdictions do not allow limitations on how long an implied warranty lasts, and some jurisdictions do not allow the exclusion or limitation of incidental or consequential damages, so the above limitations and exclusions may not apply to you. This warranty gives you special legal rights and you may have other rights which vary from jurisdiction to jurisdiction.

Copyright Protected 2021 ©



www.qfxusa.com