

PBX-264SM

QFX

WHERE THE PARTY BEGINS™



INSTRUCTION MANUAL

- VOLUME POWER:** Increase or decrease the volume
- CHARGING LIGHT**
RED= Charging
OFF= Fully Charged
- POWER SUPPLY:** (5V)/min.1A
- MODE:** The MODE button allows you to toggle through and select the speaker functions of your choice: Bluetooth, USB, SD Card, AUX, FM Radio. *(Varies on each model) Press and hold to activate the LED Party Lights
- NEXT:** Select next track or FM station.
- PLAY/PAUSE/TWS:** Play/Pause USB audio tracks. Under Bluetooth mode, press the and hold the TWS button for 3 seconds to pair another TWS speaker of the same make and model, Under FM mode, Press and hold Play/Pause & TWS to enter into automatic scan and all the scanned radio stations will be saved automatically.)
- PREV:** Select previous track or FM station.
- AUX IN:** Connect an external audio device usinfg a 3.5mm TRS audio cable.
- USB PORT:** Play back mp3 content from you USB flashdrive.
- MIC INPUT:** Connect a 6.35mm TRS cable to the input for MIC usage.

SPECIFICATIONS

Frequency Response

for main speaker: 68Hz-20KHz

Power Supply: DC5V 1A min.

*Maximum battery life is based on volume settings and usage.

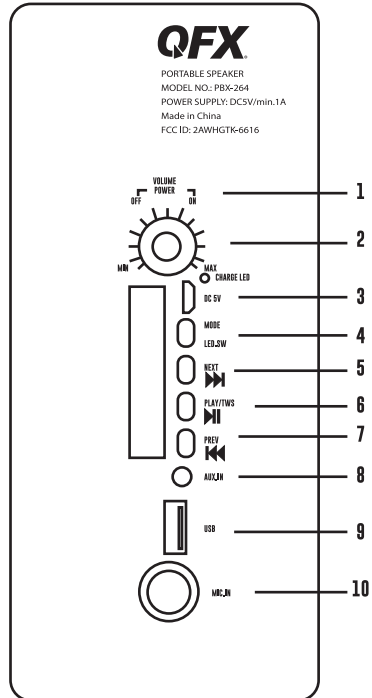

- VOLUME POWER:** sube o baja el volumen
- LUZ DE CARGA**
ROJO = Cargando
APAGADO = completamente cargado
- ALIMENTACIÓN:** (5V) /min.1A
- MODO:** El botón MODE le permite alternar y seleccionar las funciones de de elección: Bluetooth, USB, Tarjeta SD, AUX, Radio FM. *(Varía en cada modelo) Mantenga presionado para activar las luces LED para fiestas
- SIGUIENTE:** seleccione la siguiente pista o estación de FM.
- REPRODUCIR/PAUSA/TWS:** (Reproducir / pausar pistas de audio USB. En el modo Bluetooth, presione y mantenga presionado el botón TWS durante 3 segundos para emparejar otro altavoz TWS de la misma marca y modelo. En el modo FM, mantenga presionado Play / Pause & TWS para ingresar al escaneo automático y todas las estaciones de radio escaneadas se guardarán automáticamente).
- PREV:** Selecciona la pista anterior o la emisora FM.
- AUX IN:** Conecte un dispositivo de audio externo usando un cable de audio TRS de 3,5 mm.
- PUERTO USB:** reproduce contenido mp3 desde tu unidad flash USB.
- ENTRADA DE MICRÓFONO:** Conecte un cable TRS de 6,35 mm a la entrada para el uso de MIC.

- VOLUME POWER:** Augmente ou diminue le volume
- LUMIÈRE DE CHARGE**
ROUGE = Chargement
OFF = complètement chargé
- ALIMENTATION ÉLECTRIQUE:** (5V) / min.1A
- MODE:** Le bouton MODE vous permet de parcourir et de sélectionner les fonctions de haut-parleur de votre choix: Bluetooth, USB, carte SD, AUX, Radio FM. *(Varie sur chaque modèle) Appuyez et maintenez pour activer les lumières LED Party
- SUIVANT:** Sélectionnez la piste ou la station FM suivante.
- PLAY / PAUSE / TWS:** Lire/mettre en pause les pistes audio USB. En mode Bluetooth, appuyez sur le bouton TWS et maintenez-le enfoncé pendant 3 secondes pour coupler un autre haut-parleur TWS de la même marque et du même modèle. En mode FM, appuyez et maintenez Play / Pause & TWS pour entrer dans le balayage automatique et toutes les stations de radio numérisées seront enregistrées automatiquement.)
- PREV:** Sélectionnez la piste ou la station FM précédente.
- AUX IN:** connectez un périphérique audio externe à l'aide d'un câble audio TRS de 3,5 mm.
- PORT USB:** Lisez le contenu mp3 de votre clé USB.
- ENTRÉE MICRO:** Connectez un câble TRS 6,35 mm à l'entrée pour une utilisation MIC.

**TWS CONNECTION**

TWS connection: TWS Connection is only for two speakers of the same make and model.

1. Turn ON the units and enable Bluetooth mode on both speakers. They should read BLUE.
2. Press the **TWS** button for 3 seconds on one of the speakers to sync both units together.(they must be the same make and model to function).
3. On your mobile device under the Bluetooth menu, search for PBX-264SM and connect.
4. Open your favorite music app and enjoy True Wireless Stereo.
5. To Exit TWS press and hold the **TWS** button.

CONNEXION TWS

Connexion TWS: La connexion TWS est uniquement pour deux enceintes de la même marque et du même modèle.

1. Mettez les appareils sous tension et activez le mode Bluetooth sur les deux haut-parleurs. Ils devraient lire BLUE.
2. Appuyez sur le bouton TWS pendant 3 secondes sur l'un des haut-parleurs pour synchroniser les deux appareils ensemble (ils doivent être de la même marque et du même modèle pour fonctionner).
3. Sur votre appareil mobile dans le menu Bluetooth, recherchez PBX-264SM et connectez-vous.
4. Ouvrez votre application musicale préférée et profitez de True Wireless Stereo.
5. Pour quitter TWS, maintenez le bouton TWS

CONEXIÓN TWS

Conexión TWS: La conexión TWS es solo para dos altavoces de la misma marca y modelo.

1. Encienda las unidades y habilite el modo Bluetooth en ambos altavoces. Deben leer BLUE.
2. Pulse el botón TWS durante 3 segundos en uno de los altavoces para sincronizar ambas unidades (deben ser de la misma marca y modelo para funcionar).
3. En su dispositivo móvil en el menú de Bluetooth, busque PBX-264SM y conéctese.
4. Abra su aplicación de música favorita y disfrute de True Wireless Stereo.
5. Para salir de TWS, presione y mantenga presionado el botón TWS.

FOLLOW US @QFXUSA

**BLUETOOTH:**

•Bluetooth mode: use the MODE button to enable Bluetooth on the PBX-264SM. Open the Bluetooth settings on your mobile device and search for QFX PBX-264SM. Select the option to pair both devices. Now you can sit back and enjoy the music from your favorite app. You will not need to reconnect Bluetooth when changing modes.

•Modo Bluetooth: use el botón MODE para habilitar Bluetooth en el PBX-264SM. Abra la configuración de Bluetooth en su dispositivo móvil y busque QFX PBX-264SM. Seleccione la opción para emparejar ambos dispositivos. Ahora puede sentarse y disfrutar de la música de su aplicación favorita. No necesitará volver a conectar el Bluetooth al cambiar de modo.

•Mode Bluetooth: utilisez le bouton MODE pour activer Bluetooth sur le PBX-264SM. Ouvrez les paramètres Bluetooth sur votre appareil mobile et recherchez QFX PBX-264SM. Sélectionnez l'option pour coupler les deux appareils. Vous pouvez maintenant vous asseoir et profiter de la musique de votre application préférée. Vous n'aurez pas besoin de reconnecter Bluetooth lors du changement de mode.

FM RADIO:

• Frequency-Modulated stations operate in a frequency band extending from 87.5 MHz to 108 MHz. Use the MODE button to select the FM mode. In FM mode, press and hold the Play/Pause button to scan available frequencies in the area. Available stations will be stored in presets P1-99.

• Las estaciones de frecuencia modulada operan en una banda de frecuencia que se extiende desde 87.5 MHz a 108 MHz. Utilice el botón MODE para seleccionar el modo FM. En el modo FM, mantenga presionado el botón Reproducir / Pausa para buscar las frecuencias disponibles en el área. Las emisoras disponibles se almacenarán en las presintonías P1-99

•Les stations à modulation de fréquence fonctionnent dans une bande de fréquences allant de 87.5 MHz à 108 MHz. Utilisez le bouton MODE pour sélectionner le mode FM. En mode FM, maintenez le bouton Lecture / Pause enfoncé pour balayer les fréquences disponibles dans la zone. Les stations disponibles seront mémorisées dans les préséglages P1-99.

SPEAKER STAND:

- A: Take out the FASTENER, TRIPOD, and TUBE from the box.
 B: Install the FASTENER on the TRIPOD.
 C: Insert the TUBE through the FASTENER and into the TRIPOD. Adjust the desired height, tighten, and insert the PIN in the lowest hole.

- A: Saque el SUJETADOR, TRÍPODE y TUBO de la caja.
 B: Instale el FASTENER en el TRÍPODE.
 C: Inserte el TUBO a través del SUJETADOR y en el TRÍPODE. Ajuste la altura deseada, apriete e inserte el PIN en el orificio más bajo.

- A: Retirez la FIXATION, le TRÉPIED et le TUBE de la boîte.
 B: Installez la FIXATION sur le TRÉPIED.
 C: Insérez le TUBE à travers la FIXATION et dans le TRÉPIED. Ajustez la hauteur désirée, serrez et insérez le PIN dans le trou le plus bas.

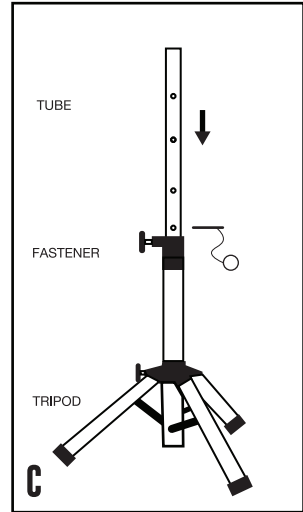
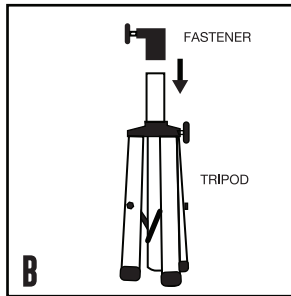
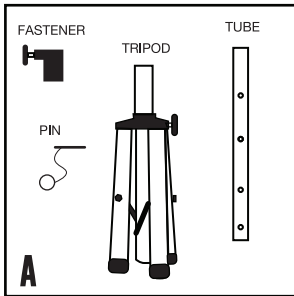
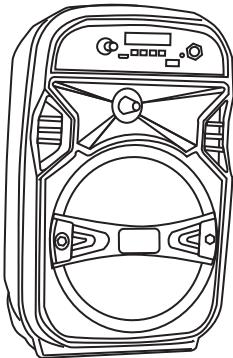
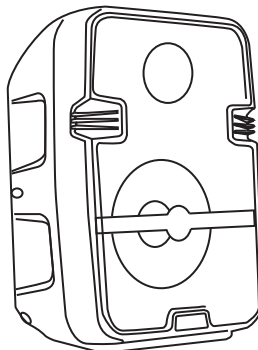
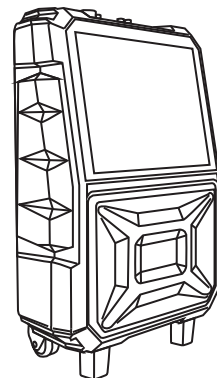
FOLLOW US @QFXUSA**CHECK OUT THESE OTHER QFX MODELS!****BT-65****BT-60****KAR-927**

Follow Us



QFXUSA.COM

**REMEMBER TO FOLLOW US ON SOCIAL
MEDIA FOR NEW RELEASES, SHOW
VIDEOS, PICTURES AND
INSTRUCTIONAL VIDEOS**

J-220

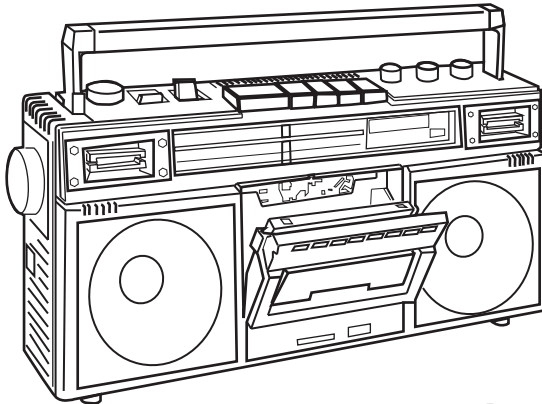

The QFX logo, with 'Q' in black and 'FX' in red. A red triangle points to the right from the bottom of the 'Q'.

WHERE THE PARTY BEGINS™



LIMITED PRODUCT WARRANTY POLICY

Before returning your Product for service under this Warranty, please (i) read the instruction manual carefully and visit our website at www.qfxusa.com for Product updates and extended support documentation (e.g., Common Troubleshooting Guides); (ii) if you are still having trouble with your Product, please contact the QFX Customer Support Department.

Subject to the terms and conditions herein, QFX, Inc. (herein after called "QFX") warrants to the original purchaser of the Product ("Customer") that for the applicable Warranty Period listed below, the Product will be free from defects in material or workmanship under normal, non-commercial use ("Defects").

Warranty Period encompasses, as listed below, separate "Coverage Periods" for Parts and Labor, each Coverage Period to begin from the original date of Customer purchase. If Customer returns a defective Product (or any component thereof) during the applicable Warranty Period, QFX will, at its option, during the specified Coverage Periods for Parts and Labor (as applicable either: (i) repair the Product (or, as applicable, any component thereof) or (ii) replace the Product (or, as applicable, any component thereof) with a new or refurbished Product (or, as applicable, any component thereof), in either case free of charge to Customer for Parts and/or Labor (as applicable) during the specified Coverage Period only, and excluding applicable shipping charges (noted below), for which the Customer is responsible. The foregoing states the Customer's exclusive remedy and QFX sole liability for breach of the limited warranty contained herein.

This warranty covers only normal use. This warranty is not transferable. QFX is not responsible for warranty replacement should the QFX label or logo be removed or should the product fail to be properly maintained or fail to function properly as a result of **misuse, abuse, immersion in liquids, improper installation, improper shipping, damage caused by disasters such as fire, flood, or service other than by QFX**. In addition, this warranty excludes any Product (or, as applicable, any component thereof) that has been subject to or Defects resulting from: (a) any neglect or misuse by a Customer, an accident, improper application, violation of operating instructions for the Product, any other Customer-induced damage, or the alteration or removal of any Product serial number; (b) any modification or repair to Product (or, as applicable, any component thereof) by any party other than QFX or a party authorized in writing by QFX; (c) any damage to Product (or, as applicable, any component thereof) due to power surges, incorrect electrical voltage, misconnection to any device, or malfunction of any device used with the Product (or, as applicable, any component thereof); (d) cosmetic damage to the Product (or, as applicable, any component thereof) caused by normal wear and tear; (e) shipping damage that occurs while the Product is in transit; (f) damage caused by heat sources, sunlight, electromagnetic conditions, or other climatic conditions or (g) any acts of God.

Product is sold to Customer for personal, non-commercial use only. Product is not warranted for Customer's commercial or rental use. In addition, Product is not warranted against failure, and should not be used by Customer for any application where (i) there is a risk that any data stored on Product will be breached or otherwise compromised, or (ii) the data stored on Product is relied upon for medical or lifesaving applications. QFX disclaims any Warranty for any of the foregoing uses to the fullest extent permitted by law. Customer assumes any and all risks associated with such uses of Product, and agrees to indemnify QFX for any damages claimed against QFX for such uses.

EXCEPT FOR EXPRESS WARRANTIES STATED ABOVE AND TO THE MAXIMUM EXTENT PERMITTED BY LAW, THE PRODUCTS ARE PROVIDED "AS IS" AND QFX DISCLAIMS ALL OTHER WARRANTIES, INCLUDING WITHOUT LIMITATION ANY IMPLIED WARRANTY (i) OF MERCHANTABILITY, (ii) OF FITNESS FOR A PARTICULAR PURPOSE, OR (iii) OF NON-INFRINGEMENT OF THIRD PARTY RIGHTS. TO THE MAXIMUM EXTENT PERMITTED BY APPLICABLE LAW, IN NO EVENT WILL QFX BE LIABLE TO CUSTOMER OR ANY THIRD PARTY FOR ANY INDIRECT, SPECIAL, INCIDENTAL, CONSEQUENTIAL, EXEMPLARY OR PUNITIVE DAMAGES, INCLUDING, WITHOUT LIMITATION, ANY LOST PROFITS OR REVENUES, LOSS OR INACCURACY OF ANY DATA OR COST OF SUBSTITUTE GOODS, REGARDLESS OF THE THEORY OF LIABILITY (INCLUDING NEGLIGENCE) AND EVEN IF QFX HAS BEEN ADVISED OF THE POSSIBILITY OF SUCH DAMAGES, QFX AGGREGATE LIABILITY TO CUSTOMER FOR ACTUAL DIRECT DAMAGES FOR ANY CAUSE WHATSOEVER SHALL BE LIMITED TO THE CUMULATIVE PRODUCT FEES PAID BY THAT CUSTOMER FOR THE PRODUCTS CAUSING THE DAMAGES, IF ANY.

This Warranty gives Customer specific rights, and Customer may also have other rights that vary from jurisdiction to jurisdiction. Warning: Some Products may contain components that are small enough to be swallowed. Please keep out of reach of children. In order for the return to be processed, you must send the Product PREPAID to the address below in the original packaging or reasonable substitute to prevent damage and include: (1) a dated sales receipt (which must have a purchase date that falls in the Warranty Period specified in the table below) that indicates the place of purchase, model number of Product, and amount paid, (2) a detailed description of Customer's problem with Product, (3) Customer's full name, phone number, and return address, (3) all of the accessories that came with the Product package must be sent along with the main Product, (4) a cashier's check or money order payable to QFX, Inc., in the amount specified for the item in the product table below for return shipping and handling. If in the case you cannot provide a money order or cashier's check, you can contact The QFX Customer Support Representative to arrange payment via credit card. No returned Product will be shipped back to a PO BOX. If a returned Product is found to have no problem and/or does not include ALL of the requirements indicated above, it may be returned back to the customer and will not be processed.



QFX USA®, Inc.

RMA Processing
Customer Support Department
2957 E. 46th Street | Vernon, CA 90058

- ✉ support@qfxusa.com
- ☎ (800) 864-CLUB (2582) or (323) 864-6900
- 🌐 qfxusa.com
- 🕒 Hours of Operation: Monday - Friday, 9am - 5pm PST

All prices and details below are for US Destinations excluding, Hawaii, Alaska and Puerto Rico. For excluded destinations and NON US destinations, please contact The QFX Customer Support Department directly for additional shipping fees and return instructions.

If you do not find your Product below, your Product model conflicts with multiple categories, and/or are unsure of which category the Product you have purchased will fall under, please contact our Customer Support Department for further instruction.

In order to determine the exact shipping cost that must be included with your product or paid for the product being returned, please refer to the table below. Please find the product you wish to return by category or model number prefix. QFX will not provide any return or refund to any customer for merchandise and will only honor the Limited Warranty restrictions mentioned in this document.

Please make sure to follow all directions prior to shipping back your item. If you are not sure what the shipping cost for your item is, or if your item category conflicts in the table below, please feel free to contact the QFX Support Department for further assistance.

| PRODUCT CATEGORY | HANDLING | LABOR | PARTS |
|---|----------|--------|--------|
| Earphones, Headphones, Pocket Radios, & Small Bluetooth vSpeakers | \$5.00 | 1 Year | 1 Year |
| Personal Stereos | \$10.00 | 1 Year | 1 Year |
| Portable Radio/Cassette | \$15.00 | 1 Year | 1 Year |
| Large Portable Radio Cassette | \$20.00 | 1 Year | 1 Year |
| Mobile Audio | \$10.00 | 1 Year | 1 Year |
| Pro Audio SBX Systems | \$75.00 | 1 Year | 1 Year |
| Pro Audio PBX Systems | \$75.00 | 1 Year | 1 Year |
| Televisions | \$25.00 | 1 Year | 1 Year |
| Telephones | \$10.00 | 1 Year | 1 Year |

THE WARRANTY AND REMEDY PROVIDED ABOVE ARE EXCLUSIVE AND IN LIEU OF ALL OTHER EXPRESSED OR IMPLIED WARRANTIES INCLUDING, BUT NOT LIMITED TO, THE IMPLIED WARRANTIES OF MERCHANTABILITY, NON-INFRINGEMENT OR FITNESS FOR A PARTICULAR PURPOSE. SOME LAWS DO NOT ALLOW THE EXCLUSION OF IMPLIED WARRANTIES. IF THESE LAWS APPLY, THEN ALL EXPRESSED OR IMPLIED WARRANTIES ARE LIMITED TO THE WARRANTY PERIOD IDENTIFIED ABOVE. UNLESS STATED HEREIN, ANY STATEMENT OR REPRESENTATIONS MADE BY ANY OTHER PERSONS OR FIRM ARE VOID. EXCEPT AS PROVIDED IN THIS WRITTEN WARRANTY, QFX SHALL NOT BE LIABLE FOR ANY LOSS, INCONVENIENCE, OR DAMAGE, INCLUDING DIRECT, SPECIAL, INCIDENTAL OR CONSEQUENTIAL DAMAGES, RESULTING FROM THE USE OR INABILITY TO USE THE QFX PRODUCT, WHETHER RESULTING FROM BREACH OF WARRANTY OR ANY OTHER LEGAL THEORY.

Some jurisdictions do not allow limitations on how long an implied warranty lasts, and some jurisdictions do not allow the exclusion or limitation of incidental or consequential damages, so the above limitations and exclusions may not apply to you. This warranty gives you special legal rights and you may have other rights which vary from jurisdiction to jurisdiction.

Copyright Protected 2021 ©



www.qfxusa.com

THANK YOU.

Enjoy your speaker and make many memories with it because
QFX is Where the Party Begins!

We would love to hear about your PBX-264SM Journey!
Tag us **@QFXUSA** to share your stories.