

PBX-2101

QFX

WHERE THE PARTY BEGINS™



INSTRUCTION MANUAL

WARNING!

TO REDUCE THE RISK OF ELECTRIC SHOCK, DO NOT REMOVE THE COVER ON THIS SPEAKER. THERE ARE NO USER-SERVICEABLE PARTS INSIDE. REFER ALL SERVICING TO A QUALIFIED TECHNICIAN

To prevent fire or electric shock, do not expose this equipment to rain or moisture. Do not store or operate this product near any liquids, heat sources such as radiators, heat registers. Clean only with a dry cloth. Users should exhibit extra safety when this symbol appears in this instruction manual and follow all precautions as they are stated.

PBX-2101 BATTERY

The PBX-2101 is a lithium battery powered PA loudspeaker.

Be sure that you have completely charged the battery prior to first use to maximize the battery's lifespan. Once the power adapter is connected to a power source, it will automatically begin charging (3~4 hours to fully charge the lithium battery) even if the battery power is low, it will power on when connected to a power source. When the battery power is low, the battery icon on the display screen will begin flashing. When the battery is fully charged, the battery icon will stay ON. Upon completion of the charging, please disconnect the unit. With standard usage, a fully charged battery can play for about 2~3 hours. Battery can be recharged about 300 times in its lifetime. When not in use, the speaker should always be set OFF to prevent the unit from draining the battery. When the unit is not used for prolonged periods of time, the battery will gradually lose its power. It is recommended to fully charge the battery at least every 60 days.

PBX-2101 REMOTE CONTROL

1. STANDBY: Make the unit to be standby mode.
2. Input Mode Button: Toggle between USB,TF,FM,AUX,BT
3. Mute: Mute the track
4. PLAY/PAUSE
5. Previous Track: Select pervious channel
6. Next Track: Select next channel,
7. EQ: Select EQ mode.
8. VOL-: Reduce the master volume
9. VOL+: Incerase the master volume
10. REP: Repeat the playing track.
11. Press to Scan Channel in FM Mode
- 12-21. KEY Number for selecting the certain track for USB flash drive or TF card.

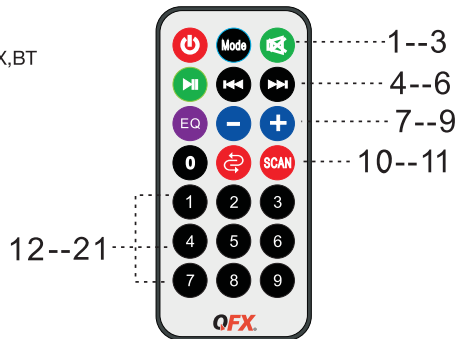
**PBX-2101 Recording Function**

Insert the USB/TF card in the slot. Connect the wired microphone, make sure it is "ON" and is working. Press and hold the "REC PLAY" to start recording sound, Then press "REC PLAY" to play recording file. Press again to exit recording function.

PBX-2101 TWS CONNECTION

- (1) TWS connection: TWS Connection is only for two speakers, can not support quantity over 2 PCS.
- (2) Turn on the Speakers , press the MODE button to switch to BLUETOOTH mode, and the word "BLUE" on the LED screen will flash.
- (3) For the first time, please press and hold down the Play/Pause (TWS) button for 3 seconds one one unit. Then the two speakers will connect together.
- (4) Connect the phone: Open the phone Bluetooth settings, Search and Connect the main device Bluetooth name 'QFX PBX-2101'.
- (5) Select music from phone and enjoy TWS playing in pairs with two Speakers.
- (6) Exit TWS: Press and hold the Play/Pause (TWS) button for 3 seconds to exit the TWS function

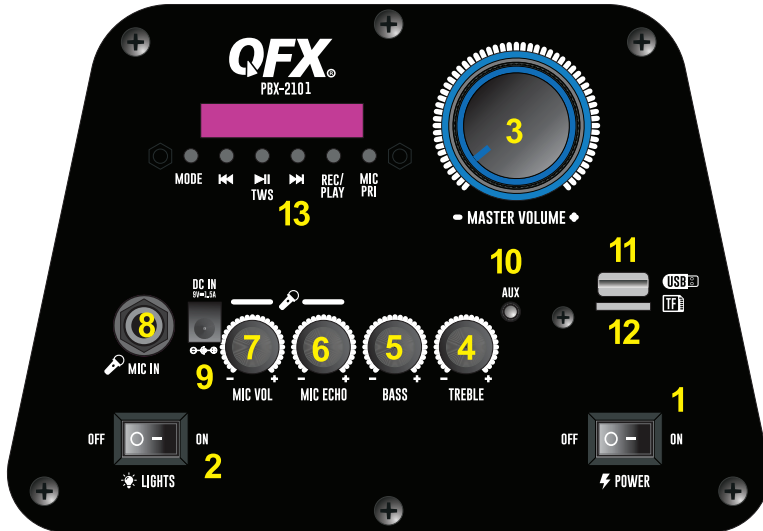

PBX-2101 TOP PANEL

1. Power Switch: ON/OFF
2. Light Switch: ON/OFF
3. Master Volume Knob: Adjust from Min to Max
4. Treble Knob: Adjust from Min to Max
5. Bass Knob: Adjust from Min to Max
6. Microphone Echo: Adjust from Min to Max
7. Microphone Volume Knob: Adjust from Min to Max
8. Microphone Input: Insert a 6.35mm TRS mic cable.
9. Power Supply: DC 9V 1.5A
10. AUX IN: Connect an external audio device via a 3.5mm TRS cable.
11. USB Port: Insert a USB Flashdrive (mp3 Format) for music playback.
12. TF Card Port: Insert a TF Card (mp3 Format) for music playback.
13. Global Control Buttons:
 - Mode Button: Toggle between AUX, USB, TF, FM, BT
 - Previous Track Button: Select Previous Track
 - Play/Pause TWS: Play and Pause music. Press and hold for TWS
 - Next Track Button: Select next track
 - REC/PLAY: Record to USB/TF Card Device
 - MIC Priority: ON/OFF-Prioritize mic over music.

PBX-2101 DISPLAY SYSTEM SETTINGS

1. Input Mode: The LED display screen will display the information of input mode for USB/TF/BT AUX /FM. When a USB flash drive / TF Card is inserted into the USB/TF input, the unit will automatically switch to USB/TF mode and begin playing Mp3 audio files from the USB flash drive / TF Card.
2. Track Number: The track number currently playing from the USB/TF will display.
3. FM Mode: All FM channels display here. Press "Play/Pause" button for auto scan all channels.

**TWS CONNECTION**

TWS connection: TWS Connection is only for two speakers of the same make and model.

1. Turn ON the units and enable Bluetooth mode on both speakers. They should read BLUE.
2. Press the **TWS** button for 3 seconds on one of the speakers to sync both units together, (they must be the same make and model to function).
3. On your mobile device under the Bluetooth menu, search for QFX PBX-2101 and connect.
4. Open your favorite music app and enjoy True Wireless Stereo.
5. To Exit TWS press and hold the **TWS** button.

CONNEXION TWS

Connexion TWS: La connexion TWS est uniquement pour deux enceintes de la même marque et du même modèle.

1. Mettez les appareils sous tension et activez le mode Bluetooth sur les deux haut-parleurs. Ils devraient lire BLUE.
2. Appuyez sur le bouton TWS pendant 3 secondes sur l'un des haut-parleurs pour synchroniser les deux appareils ensemble (ils doivent être de la même marque et du même modèle pour fonctionner).
3. Sur votre appareil mobile dans le menu Bluetooth, recherchez QFX PBX-2101 et connectez-vous.
4. Ouvrez votre application musicale préférée et profitez de True Wireless Stereo.
5. Pour quitter TWS, maintenez le bouton TWS

CONEXIÓN TWS

Conexión TWS: La conexión TWS es solo para dos altavoces de la misma marca y modelo.

1. Encienda las unidades y habilite el modo Bluetooth en ambos altavoces. Deben leer BLUE.
2. Pulse el botón TWS durante 3 segundos en uno de los altavoces para sincronizar ambas unidades (deben ser de la misma marca y modelo para funcionar).
3. En su dispositivo móvil en el menú de Bluetooth, busque QFX PBX-2101 y conéctese.
4. Abra su aplicación de música favorita y disfrute de True Wireless Stereo.
5. Para salir de TWS, presione y mantenga presionado el botón TWS.

BLUETOOTH:

• Bluetooth mode: use the MODE button to enable Bluetooth on the PBX-2101. Open the Bluetooth settings on your mobile device and search for QFX PBX-2101. Select the option to pair both devices. Now you can sit back and enjoy the music from your favorite app. You will not need to reconnect Bluetooth when changing modes.

• Modo Bluetooth: use el botón MODE para habilitar Bluetooth en el PBX-2101. Abra la configuración de Bluetooth en su dispositivo móvil y busque QFX PBX-2101. Seleccione la opción para emparejar ambos dispositivos. Ahora puede sentarse y disfrutar de la música de su aplicación favorita. No necesitará volver a conectar el Bluetooth al cambiar de modo.

• Mode Bluetooth: utilisez le bouton MODE pour activer Bluetooth sur le PBX-2101. Ouvrez les paramètres Bluetooth sur votre appareil mobile et recherchez QFX PBX-2101. Sélectionnez l'option pour coupler les deux appareils. Vous pouvez maintenant vous asseoir et profiter de la musique de votre application préférée. Vous n'aurez pas besoin de reconnecter Bluetooth lors du changement de mode.

FM RADIO:

• Frequency-Modulated stations operate in a frequency band extending from 87.8 MHz to 108 MHz. Use the MODE button to select the FM mode. In FM mode, press and hold the Play/Pause button to scan available frequencies in the area. Extend the telescoping antenna to enhance reception. Available stations will be stored in presets P1-99.

• Las estaciones de frecuencia modulada operan en una banda de frecuencia que se extiende desde 87.8 MHz a 108 MHz. Utilice el botón MODE para seleccionar el modo FM. En el modo FM, mantenga presionado el botón Reproducir / Pausa para buscar las frecuencias disponibles en el área. Extienda la antena telescópica para mejorar la recepción. Las emisoras disponibles se almacenarán en las presintonías P1-99

• Les stations à modulation de fréquence fonctionnent dans une bande de fréquences allant de 87.8 MHz à 108 MHz. Utilisez le bouton MODE pour sélectionner le mode FM. En mode FM, maintenez le bouton Lecture / Pause enfoncé pour balayer les fréquences disponibles dans la zone. Déployez l'antenne télescopique pour améliorer la réception. Les stations disponibles seront mémorisées dans les préséglages P1-99.

¡ADVERTENCIA!

PARA REDUCIR EL RIESGO DE DESCARGAS ELÉCTRICAS, NO RETIRE LA CUBIERTA DE ESTE ALTAVOZ. NO HAY PARTES REPARABLES POR EL USUARIO ADENTRO. CONSULTE TODO EL SERVICIO A UN TÉCNICO CALIFICADO

Para evitar incendios o descargas eléctricas, no exponga este equipo a la lluvia o la humedad. No almacene ni opere este producto cerca de líquidos, fuentes de calor como radiadores, registros de calor. Limpiar solamente con un paño seco. Los usuarios deben exhibir seguridad adicional cuando este símbolo aparece en este manual de instrucciones y seguir todas las precauciones tal como se indican.

BATERÍA PBX-2101

El PBX-2101 es un altavoz de megafonía alimentado por batería de litio.

Asegúrese de haber cargado completamente la batería antes del primer uso para maximizar la capacidad de la batería. Una vez que el adaptador de corriente está conectado a una fuente de alimentación, comenzará a cargarse automáticamente (3 ~ 4 horas para cargar completamente la batería de litio) incluso si la carga de la batería es baja, se encenderá cuando conectado a una fuente de alimentación. Cuando la carga de la batería es baja, el icono de la batería en la pantalla comenzará a parpadear. Cuando la batería está completamente cargada, el icono de la batería permanecerá encendido. Una vez completada la carga, desconecte la unidad. Con el uso estándar, una batería completamente cargada puede funcionar durante aproximadamente 2 a 3 horas, mientras que la batería se puede recargar unas 300 veces durante su vida útil. Cuando no esté en uso, el altavoz siempre debe estar APAGADO para evitar que la unidad agote la batería. Cuando la unidad no se utiliza durante períodos prolongados de tiempo, la batería perderá gradualmente su energía. Se recomienda cargar completamente la batería al menos cada 60 días.

PBX-2101 CONTROL REMOTO

1. EN ESPERA: Haga que la unidad esté en modo de espera.
2. Botón de modo de entrada: alterna entre USB, TF, FM, AUX, BT
3. Silencio: silencia la pista
4. JUGAR / PAUSAR
5. Pista anterior: Seleccionar canal anterior
6. Siguiete pista: seleccione el siguiente canal.
7. EQ: selecciona el modo EQ.
8. VOL-: reduce el volumen maestro
9. VOL +: Incrementa el volumen maestro
10. REP: repite la pista de reproducción.
11. Presione para escanear canales en modo FM
- 12-21. Número CLAVE para seleccionar la pista determinada para unidad flash USB o tarjeta TF.

12--21

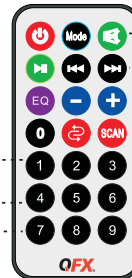

-----1--3

-----4--6

-----7--9

-----10--11

Función de grabación PBX-2101

Inserte la tarjeta USB / TF en la ranura. Conecte el micrófono con cable, asegúrese de que esté encendido y de que funcione. Presione y mantenga presionado "REC PLAY" para comenzar a grabar el sonido, luego presione "REC PLAY" para reproducir el archivo de grabación.

Presione nuevamente para salir de la función de grabación.

PBX-2101 TWS CONEXIÓN

- (1) Conexión TWS: la conexión TWS es solo para dos altavoces, no puede admitir cantidades superiores a 2 PCS.
- (2) Encienda los altavoces, presione el botón MODE para cambiar al modo BLUETOOTH y la palabra "BLUE" en la pantalla LED parpadeará.
- (3) Por primera vez, presione y mantenga presionado el botón Reproducir / Pausa (TWS) durante 3 segundos en una unidad. Luego, los dos altavoces se conectarán entre sí.
- (4) Conecte el teléfono: abra la configuración de Bluetooth del teléfono, busque y conecte el dispositivo principal Bluetooth Nombre "QFX PBX-2101".
- (5) Seleccione música del teléfono y disfrute de TWS jugando en parejas con dos altavoces.
- (6) Salir de TWS: mantenga presionado el botón Reproducir / Pausa (TWS) durante 3 segundos para salir de la función TWS

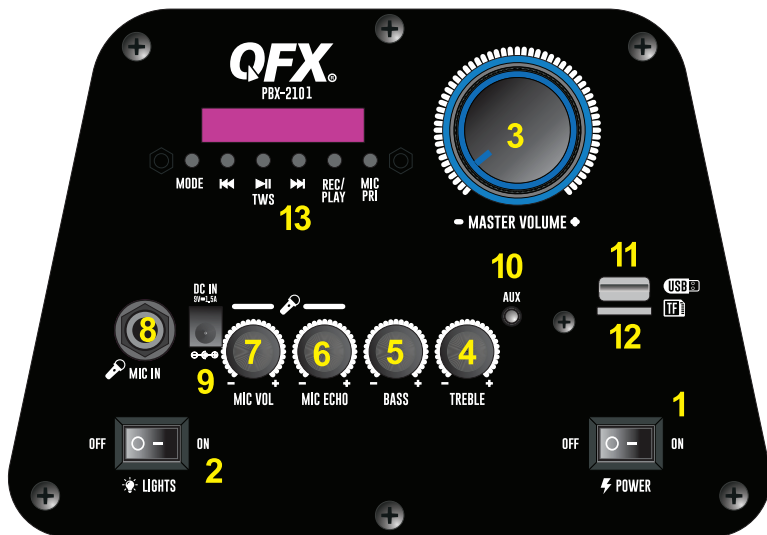

PBX-2101 PANEL SUPERIOR

1. Interruptor de encendido: ENCENDIDO / APAGADO
2. Interruptor de luz: ENCENDIDO / APAGADO
3. Perilla de volumen maestro: ajuste de mínimo a máximo
4. Perilla de agudos: ajuste de mínimo a máximo
5. Perilla de graves: ajuste de mínimo a máximo
6. Eco de micrófono: ajuste de mínimo a máximo
7. Perilla de volumen del micrófono: ajuste de mínimo a máximo
8. Entrada de micrófono: Inserte un cable de micrófono TRS de 6,35 mm.
9. Fuente de alimentación: DC 9V 1.5A
10. AUX IN: Conecte un dispositivo de audio externo mediante un cable TRS de 3,5 mm.
11. Puerto USB: inserte una unidad flash USB (formato mp3) para reproducir música.
12. Puerto de tarjeta TF: inserte una tarjeta TF (formato mp3) para reproducir música.
13. Botones de control global:
 - Botón de modo: alternar entre AUX, USB, TF, FM, BT
 - Botón de pista anterior: seleccione la pista anterior
 - Reproducir / Pausar TWS: reproducir y pausar música. Mantenga pulsado para TWS
 - Botón de pista siguiente: seleccione la pista siguiente
 - REC / PLAY: Grabar en dispositivo de tarjeta USB / TF
 - Prioridad MIC: ON / OFF-Prioriza el micrófono sobre la música.

FOLLOW US @QFXUSA



PBX-2101 PANTALLA AJUSTES DEL SISTEMA

1. Modo de entrada: la pantalla LED mostrará la información del modo de entrada para USB / TF / BT AUX / FM. Cuando se inserta una unidad flash USB / tarjeta TF en la entrada USB / TF, la unidad automáticamente cambie al modo USB / TF y comience a reproducir archivos de audio Mp3 desde la unidad flash USB / tarjeta TF.
2. Número de pista: se mostrará el número de pista que se reproduce actualmente desde el USB / TF.
3. Modo FM: aquí se muestran todos los canales FM. Presione brevemente el botón "reproducir / pausa" para escanear automáticamente todos los canales.

SPEAKER STAND:

A: Take out the FASTENER, TRIPOD, and TUBE from the box.

B: Install the FASTENER on the TRIPOD.

C: Insert the TUBE through the FASTENER and into the TRIPOD. Adjust the desired height, tighten, and insert the PIN in the lowest hole.

A: Saque el SUJETADOR, TRÍPODE y TUBO de la caja.

B: Instale el FASTENER en el TRÍPODE.

C: Inserte el TUBO a través del SUJETADOR y en el TRÍPODE. Ajuste la altura deseada, apriete e inserte el PIN en el orificio más bajo.

A: Retirez la FIXATION, le TRÉPIED et le TUBE de la boîte.

B: Installez la FIXATION sur le TRÉPIED.

C: Insérez le TUBE à travers la FIXATION et dans le TRÉPIED. Ajustez la hauteur désirée, serrez et insérez le PIN dans le trou le plus bas.

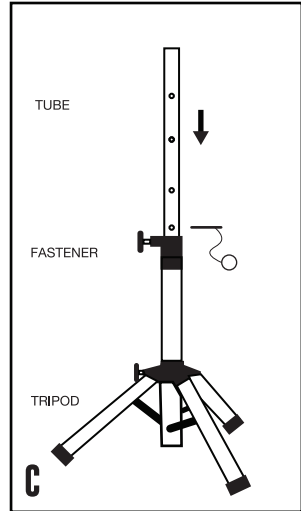
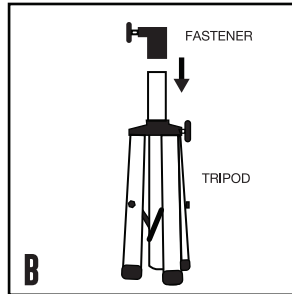
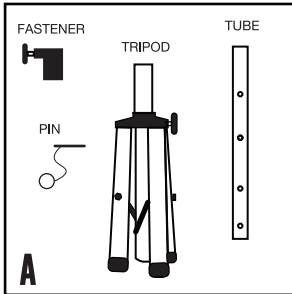
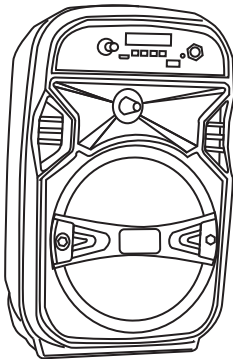
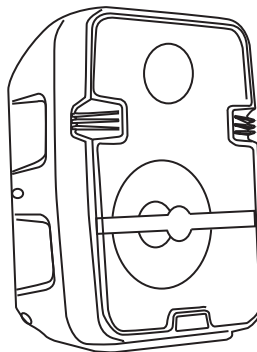
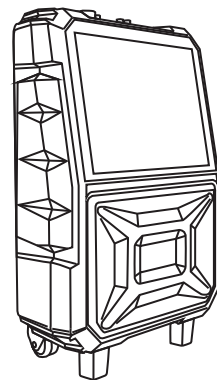
FOLLOW US @QFXUSA**CHECK OUT THESE OTHER QFX MODELS!****BT-65****BT-60****KAR-927**

ATTENTION!

POUR RÉDUIRE LE RISQUE DE CHOC ÉLECTRIQUE, N'ENLEVEZ PAS LE COUVERCLE DE CET ENCEINTE. IL N'Y A AUCUNE PIÈCE RÉPARABLE PAR L'UTILISATEUR. RÉFÉREZ TOUTES LES RÉPARATIONS À UN TECHNICIEN QUALIFIÉ

Pour éviter tout incendie ou choc électrique, n'exposez pas cet équipement à la pluie ou à l'humidité. Ne pas stocker ou faire fonctionner ce produit à proximité de liquides, sources de chaleur telles que radiateurs, registres de chaleur. Nettoyez uniquement avec un chiffon sec. Les utilisateurs doivent faire preuve d'une sécurité supplémentaire lorsque ce symbole apparaît dans ce manuel d'instructions et suivre toutes les précautions telles qu'elles sont indiquées.

BATTERIE PBX-2101

Le PBX-2101 est un haut-parleur PA alimenté par batterie au lithium.

Assurez-vous que vous avez complètement chargé la batterie avant la première utilisation afin de maximiser la capacité de la batterie, durée de vie. Une fois que l'adaptateur secteur est connecté à une source d'alimentation, il commencera automatiquement à charger (3 ~ 4 heures pour charger complètement la batterie au lithium) même si la batterie est faible, elle s'allumera lorsque connecté à une source d'alimentation. Lorsque la charge de la batterie est faible, l'icône de la batterie sur l'écran d'affichage commence à clignoter. Lorsque la batterie est complètement chargée, l'icône de la batterie reste allumée. Une fois la charge terminée, veuillez déconnecter l'appareil. Avec une utilisation standard, une batterie complètement chargée peut fonctionner pendant environ 2 à 3 heures. La batterie peut être rechargée environ 300 fois au cours de sa durée de vie. Lorsqu'il n'est pas utilisé, le haut-parleur doit toujours être réglé sur OFF pour éviter que l'appareil ne décharge la batterie. Lorsque l'appareil n'est pas utilisé pendant des périodes prolongées, la batterie perd progressivement sa puissance. Il est recommandé de charger complètement la batterie au moins tous les 60 jours.

PBX-2101 TÉLÉCOMMANDE

1. STANDBY: mettre l'appareil en mode veille.
2. Bouton de mode d'entrée: basculez entre USB, TF, FM, AUX, BT
3. Muet: couper le son de la piste
4. LECTURE / PAUSE
5. Piste précédente: sélectionnez la chaîne perméable
6. Piste suivante: sélectionnez la chaîne suivante.
7. EQ: sélectionnez le mode EQ.
8. VOL-: Réduisez le volume principal
9. VOL+: Incréase le volume principal
10. REP: Répéter la piste en cours de lecture.
11. Appuyez sur pour balayer la chaîne en mode FM
- 12-21. Numéro de clé pour sélectionner la certaine piste pour clé USB ou carte TF.

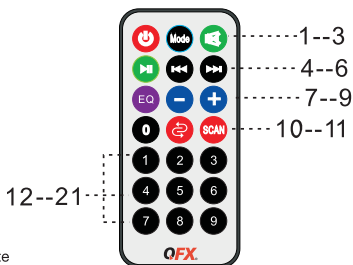
**Fonction d'enregistrement PBX-2101**

Insérez la carte USB / TF dans la fente. Connectez le microphone filaire, assurez-vous qu'il est sur «ON» et qu'il fonctionne. Appuyez et maintenez la touche «REC PLAY» pour démarrer l'enregistrement du son, puis appuyez sur «REC PLAY» pour lire le fichier d'enregistrement. Appuyez à nouveau pour quitter la fonction d'enregistrement.

PBX-2101 TWS CONNEXION

- (1) Connexion TWS: La connexion TWS est uniquement pour deux haut-parleurs, ne peut pas prendre en charge une quantité supérieure à 2 PCS.
- (2) Allumez les haut-parleurs, appuyez sur le bouton MODE pour passer en mode BLUETOOTH et le mot "BLUE" sur l'écran LED clignote.
- (3) Pour la première fois, appuyez sur le bouton Lecture / Pause (TWS) et maintenez-le enfoncé pendant 3 secondes une unité. Ensuite, les deux haut-parleurs se connecteront ensemble.
- (4) Connecter le téléphone: ouvrez les paramètres Bluetooth du téléphone, recherchez et connectez le périphérique principal Bluetooth Nommez «QFX PBX-2101».
- (5) Sélectionnez la musique du téléphone et profitez de TWS en jouant avec deux haut-parleurs.
- (6) Quitter TWS: appuyez longuement sur le bouton Lecture / Pause (TWS) pendant 3 secondes pour quitter la fonction TWS

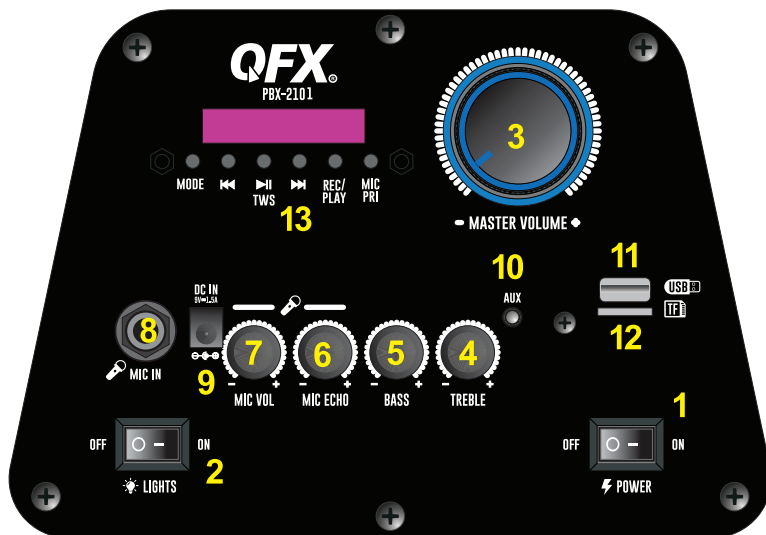

PBX-2101 PANNEAU SUPÉRIEUR

1. Interrupteur d'alimentation: ON / OFF
2. Interrupteur d'éclairage: ON / OFF
3. Bouton de volume principal: ajustez de Min à Max
4. Bouton Treble: Ajustez de Min à Max
5. Bouton Bass: Ajustez de Min à Max
6. Écho du microphone: Ajustez de Min à Max
7. Bouton de volume du microphone: ajustez de Min à Max
8. Entrée microphone: insérez un câble micro TRS 6,35 mm.
9. Alimentation: DC 9V 1.5A
10. AUX IN: connectez un appareil audio externe via un câble TRS de 3,5 mm.
11. Port USB: insérez une clé USB (format mp3) pour la lecture de musique.
12. Port de la carte TF: insérez une carte TF (format mp3) pour la lecture de musique.
13. Boutons de contrôle global:
 - Bouton de mode: basculer entre AUX, USB, TF, FM, BT
 - Bouton de piste précédente: sélectionnez la piste précédente
 - Lecture / Pause TWS: lecture et pause de la musique. Appuyez et maintenez pour TWS
 - Bouton de piste suivante: sélectionnez la piste suivante
 - REC / PLAY: Enregistrer sur un périphérique de carte USB / TF
 - Priorité MIC: ON / OFF-Prioritize micro sur la musique.

PBX-2101 PARAMÈTRES DU SYSTÈME D'AFFICHAGE

1. Mode d'entrée: L'écran d'affichage LED affichera les informations du mode d'entrée pour USB / TF / BT AUX / FM. Lorsqu'un lecteur flash USB / une carte TF est inséré dans l'entrée USB / TF, l'appareil passe en mode USB / TF et commence à lire des fichiers audio MP3 à partir du lecteur flash USB / de la carte TF.
2. Numéro de piste: Le numéro de piste en cours de lecture depuis l'USB / TF s'affiche.
3. Mode FM: toutes les chaînes FM s'affichent ici. Appuyez brièvement sur le bouton "lecture / pause" pour rechercher automatiquement toutes les chaînes.



LIMITED PRODUCT WARRANTY POLICY

Before returning your Product for service under this Warranty, please (i) read the instruction manual carefully and visit our website at www.qfxusa.com for Product updates and extended support documentation (e.g., Common Troubleshooting Guides); (ii) if you are still having trouble with your Product, please contact the QFX Customer Support Department.

Subject to the terms and conditions herein, QFX, Inc. (herein after called "QFX") warrants to the original purchaser of the Product ("Customer") that for the applicable Warranty Period listed below, the Product will be free from defects in material or workmanship under normal, non-commercial use ("Defects").

Warranty Period encompasses, as listed below, separate "Coverage Periods" for Parts and Labor, each Coverage Period to begin from the original date of Customer purchase. If Customer returns a defective Product (or any component thereof) during the applicable Warranty Period, QFX will, at its option, during the specified Coverage Periods for Parts and Labor (as applicable either: (i) repair the Product (or, as applicable, any component thereof) or (ii) replace the Product (or, as applicable, any component thereof) with a new or refurbished Product (or, as applicable, any component thereof), in either case free of charge to Customer for Parts and/or Labor (as applicable) during the specified Coverage Period only, and excluding applicable shipping charges (noted below), for which the Customer is responsible. The foregoing states the Customer's exclusive remedy and QFX sole liability for breach of the limited warranty contained herein.

This warranty covers only normal use. This warranty is not transferable. QFX is not responsible for warranty replacement should the QFX label or logo be removed or should the product fail to be properly maintained or fail to function properly as a result of **misuse, abuse, immersion in liquids, improper installation, improper shipping, damage caused by disasters such as fire, flood, or service other than by QFX**. In addition, this warranty excludes any Product (or, as applicable, any component thereof) that has been subject to or Defects resulting from: (a) any neglect or misuse by a Customer, an accident, improper application, violation of operating instructions for the Product, any other Customer-induced damage, or the alteration or removal of any Product serial number; (b) any modification or repair to Product (or, as applicable, any component thereof) by any party other than QFX or a party authorized in writing by QFX; (c) any damage to Product (or, as applicable, any component thereof) due to power surges, incorrect electrical voltage, misconnection to any device, or malfunction of any device used with the Product (or, as applicable, any component thereof); (d) cosmetic damage to the Product (or, as applicable, any component thereof) caused by normal wear and tear; (e) shipping damage that occurs while the Product is in transit; (f) damage caused by heat sources, sunlight, electromagnetic conditions, or other climatic conditions or (g) any acts of God.

Product is sold to Customer for personal, non-commercial use only. Product is not warranted for Customer's commercial or rental use. In addition, Product is not warranted against failure, and should not be used by Customer for any application where (i) there is a risk that any data stored on Product will be breached or otherwise compromised, or (ii) the date stored on Product is relied upon for medical or lifesaving applications. QFX disclaims any Warranty for any of the foregoing uses to the fullest extent permitted by law. Customer assumes any and all risks associated with such uses of Product, and agrees to indemnify QFX for any damages claimed against QFX for such uses.

EXCEPT FOR EXPRESS WARRANTIES STATED ABOVE AND TO THE MAXIMUM EXTENT PERMITTED BY LAW, THE PRODUCTS ARE PROVIDED "AS IS" AND QFX DISCLAIMS ALL OTHER WARRANTIES, INCLUDING WITHOUT LIMITATION ANY IMPLIED WARRANTY (i) OF MERCHANTABILITY, (ii) OF FITNESS FOR A PARTICULAR PURPOSE, OR (iii) OF NON-INFRINGEMENT OF THIRD PARTY RIGHTS. TO THE MAXIMUM EXTENT PERMITTED BY APPLICABLE LAW, IN NO EVENT WILL QFX BE LIABLE TO CUSTOMER OR ANY THIRD PARTY FOR ANY INDIRECT, SPECIAL, INCIDENTAL, CONSEQUENTIAL, EXEMPLARY OR PUNITIVE DAMAGES, INCLUDING, WITHOUT LIMITATION, ANY LOST PROFITS OR REVENUES, LOSS OR INACCURACY OF ANY DATA OR COST OF SUBSTITUTE GOODS, REGARDLESS OF THE THEORY OF LIABILITY (INCLUDING NEGLIGENCE) AND EVEN IF QFX HAS BEEN ADVISED OF THE POSSIBILITY OF SUCH DAMAGES, QFX AGGREGATE LIABILITY TO CUSTOMER FOR ACTUAL DIRECT DAMAGES FOR ANY CAUSE WHATSOEVER SHALL BE LIMITED TO THE CUMULATIVE PRODUCT FEES PAID BY THAT CUSTOMER FOR THE PRODUCTS CAUSING THE DAMAGES, IF ANY.

This Warranty gives Customer specific rights, and Customer may also have other rights that vary from jurisdiction to jurisdiction. Warning: Some Products may contain components that are small enough to be swallowed. Please keep out of reach of children. In order for the return to be processed, you must send the Product PREPAID to the address below in the original packaging or reasonable substitute to prevent damage and include: (1) a dated sales receipt (which must have a purchase date that falls in the Warranty Period specified in the table below) that indicates the place of purchase, model number of Product, and amount paid, (2) a detailed description of Customer's problem with Product, (3) Customer's full name, phone number, and return address, (3) all of the accessories that came with the Product package must be sent along with the main Product, (4) a cashier's check or money order payable to QFX, Inc., in the amount specified for the item in the product table below for return shipping and handling. If in the case you cannot provide a money order or cashier's check, you can contact The QFX Customer Support Representative to arrange payment via credit card. No returned Product will be shipped back to a PO BOX. If a returned Product is found to have no problem and/or does not include ALL of the requirements indicated above, it may be returned back to the customer and will not be processed.

QFX USA® , Inc.
RMA Processing
Customer Support Department
2957 E. 46th Street | Vernon, CA 90058

✉ support@qfxusa.com
☎ (800) 864-CLUB (2582) or (323) 864-6900
🌐 qfxusa.com
🕒 Hours of Operation: Monday - Friday, 9am - 5pm PST

All prices and details below are for US Destinations excluding, Hawaii, Alaska and Puerto Rico. For excluded destinations and NON US destinations, please contact The QFX Customer Support Department directly for additional shipping fees and return instructions.

If you do not find your Product below, your Product model conflicts with multiple categories, and/or are unsure of which category the Product you have purchased will fall under, please contact our Customer Support Department for further instruction.

In order to determine the exact shipping cost that must be included with your product or paid for the product being returned, please refer to the table below. Please find the product you wish to return by category or model number prefix. QFX will not provide any return or refund to any customer for merchandise and will only honor the Limited Warranty restrictions mentioned in this document.

Please make sure to follow all directions prior to shipping back your item. If you are not sure what the shipping cost for your item is, or if your item category conflicts in the table below, please feel free to contact the QFX Support Department for further assistance.

PRODUCT CATEGORY	HANDLING	LABOR	PARTS
Earphones, Headphones, Pocket Radios, & Small Bluetooth vSpeakers	\$5.00	1 Year	1 Year
Personal Stereos	\$10.00	1 Year	1 Year
Portable Radio/Cassette	\$15.00	1 Year	1 Year
Large Portable Radio Cassette	\$20.00	1 Year	1 Year
Mobile Audio	\$10.00	1 Year	1 Year
Pro Audio SBX Systems	\$75.00	1 Year	1 Year
Pro Audio PBX Systems	\$75.00	1 Year	1 Year
Televisions	\$25.00	1 Year	1 Year
Telephones	\$10.00	1 Year	1 Year

THE WARRANTY AND REMEDY PROVIDED ABOVE ARE EXCLUSIVE AND IN LIEU OF ALL OTHER EXPRESSED OR IMPLIED WARRANTIES INCLUDING, BUT NOT LIMITED TO, THE IMPLIED WARRANTIES OF MERCHANTABILITY, NON-INFRINGEMENT OR FITNESS FOR A PARTICULAR PURPOSE. SOME LAWS DO NOT ALLOW THE EXCLUSION OF IMPLIED WARRANTIES. IF THESE LAWS APPLY, THEN ALL EXPRESSED OR IMPLIED WARRANTIES ARE LIMITED TO THE WARRANTY PERIOD IDENTIFIED ABOVE. UNLESS STATED HEREIN, ANY STATEMENT OR REPRESENTATIONS MADE BY ANY OTHER PERSONS OR FIRM ARE VOID. EXCEPT AS PROVIDED IN THIS WRITTEN WARRANTY, QFX SHALL NOT BE LIABLE FOR ANY LOSS, INCONVENIENCE, OR DAMAGE, INCLUDING DIRECT, SPECIAL, INCIDENTAL OR CONSEQUENTIAL DAMAGES, RESULTING FROM THE USE OR INABILITY TO USE THE QFX PRODUCT, WHETHER RESULTING FROM BREACH OF WARRANTY OR ANY OTHER LEGAL THEORY.

Some jurisdictions do not allow limitations on how long an implied warranty lasts, and some jurisdictions do not allow the exclusion or limitation of incidental or consequential damages, so the above limitations and exclusions may not apply to you. This warranty gives you special legal rights and you may have other rights which vary from jurisdiction to jurisdiction.

Copyright Protected 2021 ©



www.qfxusa.com

THANK YOU.

Enjoy your speaker and make many memories with it because
QFX is Where the Party Begins!

We would love to hear about your PBX-2101 Journey!
Tag us **@QFXUSA** to share your stories.